



Frequency Reconfigurable Antenna for 5G Applications at n77 and n78 Bands

Rangarao Orugu^{1,2} , Nesasudha Moses¹ , and Doondi Kumar Janapala^{1,2} 

¹ Karunya Institute of Technology and Sciences, Coimbatore 641114, Tamilnadu, India
ranga.mouni@gmail.com

² Vishnu Institute of Technology, Bhimavaram 534202, Andhra Pradesh, India

Abstract. A frequency reconfigurable antenna is designed and presented for 5G applications. The proposed antenna is designed by using two T shaped patches positioned inversely to each other and connected by a PIN diode. Here the bottom T shaped patch is inverted and connected to the micro strip line feeding. FR4 substrate is used as dielectric and the backside ground is maintained partial with a rectangular open slot is etched opposite to the feed point. The PIN diode acts as a switch to change the operating frequency of the proposed antenna in-between n77 and n78 bands of 5G applications. The simulated analysis of proposed 5G antenna showed that, when diode is in OFF conditions it operates at 3.5 GHz with operational band covers from 3.34 GHz to 3.7 GHz. Similarly, when diode is in ON condition the antenna operated at 3.7 GHz with operational band covering from 3.47 GHz to 3.94 GHz. The performance of the frequency reconfigurable 5G antenna for OFF and ON conditions is compared with the help of S_{11} vs frequency, VSWR and radiation pattern curves and presented. The proposed antenna maintained similar radiation coverage at respective resonant frequencies for OFF and ON conditions making it suitable for future 5G applications.

Keywords: 5G · n78 band · n77 band · PIN diode · Frequency Reconfigurable

1 Introduction

The reconfigurable antennas capable of adjusting their performance based on the tuning provided can help in many ways in serving different applications by single antenna. An antenna which can operate at different band of frequencies when tuned can serve multipurpose. Similarly antenna having the capability of altering its radiation pattern to desired direction can help in many ways in communications systems in improving the signal strength in desired direction or reducing the coverage in unwanted region. These reconfigurable antennas garnered much attention in recent times. Frequency reconfigurable antenna where a single antenna can be made to serve different operational bands based on the switching condition provided has several advantages in multi application purpose communication systems. Different techniques are used to provide switching for reconfigurable antennas [1]. One of the most commonly used techniques is utilizing PIN diodes appropriate place in the antenna design [2].

Over the years different frequency reconfigurable antenna are being developed to serve various applications [3–8]. For UWB model the frequency selection can be based on which bands need to be passed or filtered, based on the requirement the operational bands can be tuned [9]. The frequency/radiation steerable antennas find applications majorly in Wireless Sensor Networks (WSN) [10]. In recent times reconfigurable antennas for LTE and 5G applications achieved more attention by researchers. These antennas are developed for lower frequency of operation to mm-wave applications [11–14]. In 5G new radio (NR), the n77 band covers from 3.3 GHz to 4.2 GHz with operational frequency at 3.7 GHz and n78 band covers from 3.3 GHz to 3.8 GHz with operating frequency maintained at 3.5 GHz [15, 16].

In the current work a single diode is used to switch the operating frequency of the antenna. The designed antenna has two T shaped patches connected by the diode and fed by micro-strip feeding. The diode OFF and ON conditions helped in reconfiguring the antenna operating frequency to operate at n78 and n77 bands respectively.

2 Frequency Reconfigurable 5G Antenna Design

2.1 5G Antenna Design

The proposed frequency reconfigurable 5G antenna design is illustrated in the following Fig. 1 and the geometrical dimensions in mm are listed in Table 1. The radiating element consists of two T shaped patches, where the first patch is positioned inversely. One side it is connected by a microstrip feed line and another side it is connected to the second T shaped patch via PIN diode. The PIN diode used in this design is BAR 64-02V diode. The diode forward and reverse biasing conditions are explained in the following Fig. 2. The diode OFF and ON conditions helped in switching the operating frequency from 3.5 GHz to 3.7 GHz. The ground plane of the antenna is maintained partial with an open slot at center part of the top side. The antenna used FR4 substrate with dielectric constant 4.4 and the overall dimensions of the antenna in XYZ directions are $25 \times 20 \times 1.6 \text{ mm}^3$.

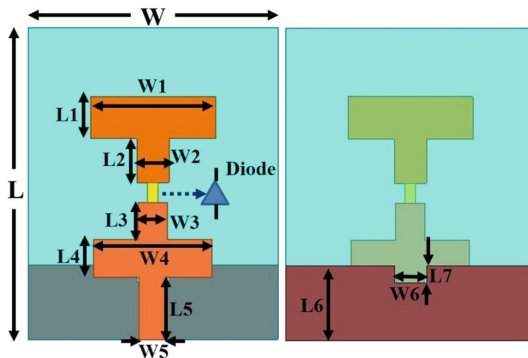
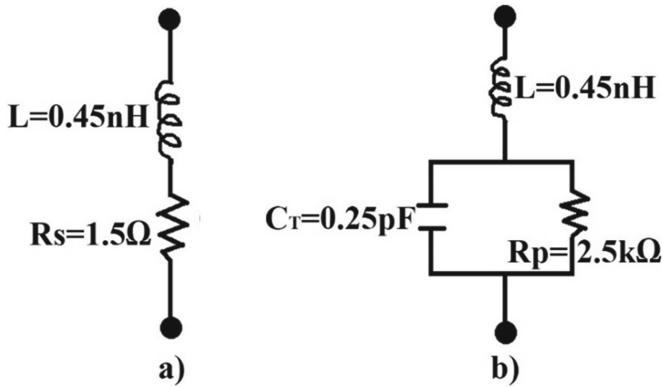

Fig. 1. Design of the proposed frequency reconfigurable 5G antenna

Table 1. 5G reconfigurable antenna design parameters in (mm).

Parameter	Value (mm)	Parameter	Value (mm)
L	25	W	20
L1	3.4	W1	10
L2	3.5	W2	2.6
L3	3	W3	2.4
L4	3	W4	9.5
L5	5	W5	2.2
L6	6	W6	2.6
L7	1.4		

**Fig. 2.** BAR 64-02V PIN diode biasing conditions

3 Parametric Study

The above-mentioned suitable dimensions in Table 1 are obtained from parametric study. Change in some of these parameters can affect the performance of the antenna. The parametric study analysis for few selected dimensions with the help of S_{11} vs frequency curves are presented in this section.

3.1 W1, W2, W4, L3 and L4 Dimensions Parametric Study

The dimensions selected for parametric study are from the two T shaped patches. The top T patch dimension W1 and W2 effect on antenna performance for diode OFF and ON conditions are presented in the following Figs. 3 & 4. Where it can be observed from Fig. 3 that the dimension W1 effects the antenna operating frequency drastically as W1 increases, the operating frequency shifts towards lower resonance with a decline in impedance matching. Here for $W1 = 10$ mm the antenna maintained operating frequency near at 3.5 GHz for OFF condition and at 3.7 GHz for ON condition.

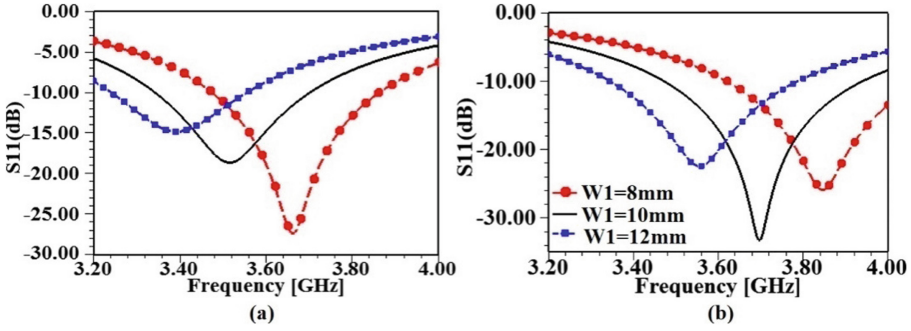

Fig. 3. S_{11} vs Frequency curve comparison for W_1 variation a) Diode OFF and b) Diode ON

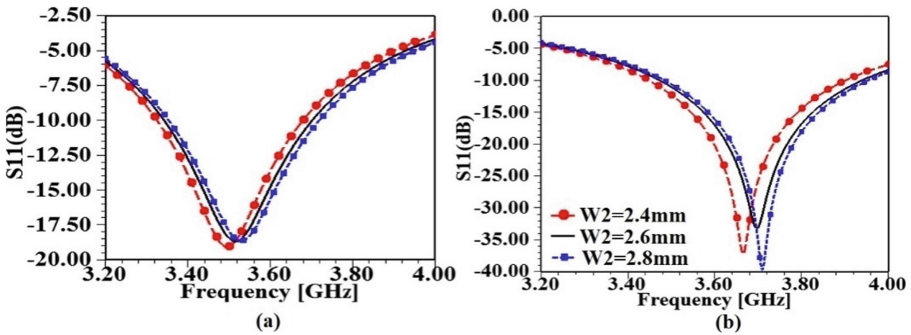

Fig. 4. S_{11} vs Frequency curve comparison for W_2 variation a) Diode OFF and b) Diode ON

Similarly, from Fig. 4 for dimension W_2 the shift in operating frequency is less as the step size of the dimension is less. In view of the required operating frequencies for n78 and n77 bands $W_2 = 2.6$ mm is selected.

The bottom T patch dimensions W_4 , L_3 and L_4 varied and the S_{11} vs frequency curves comparison is presented in the following Figs. 5, 6 and 7.

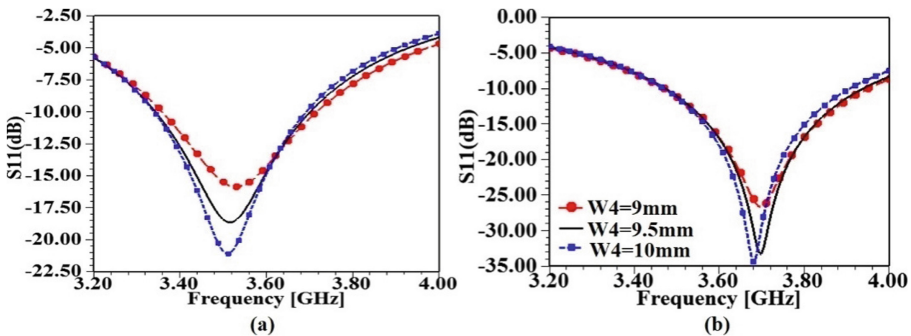

Fig. 5. S_{11} vs Frequency curve comparison for W_4 variation a) Diode OFF and b) Diode ON

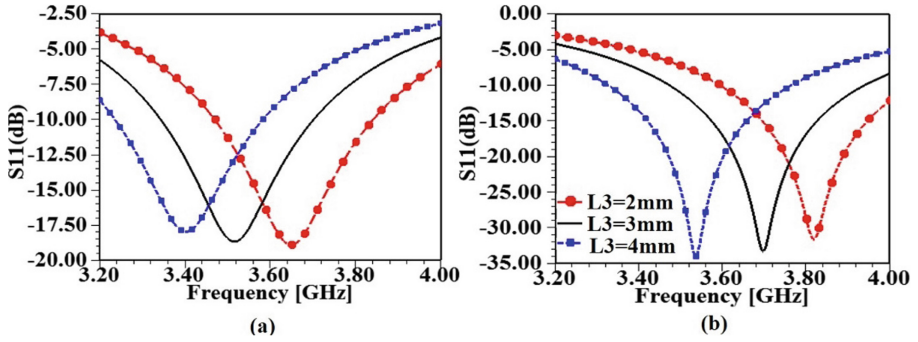

Fig. 6. S_{11} vs Frequency curve comparison for L_3 variation a) Diode OFF and b) Diode ON

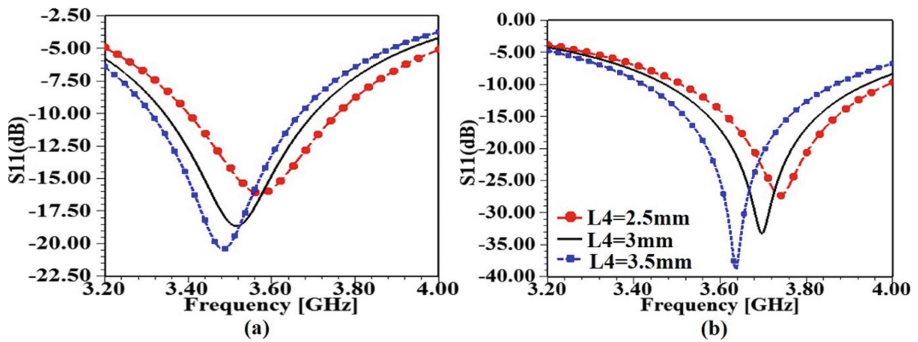

Fig. 7. S_{11} vs Frequency curve comparison for L_4 variation a) Diode OFF and b) Diode ON

From Fig. 5 it can be seen that, for W_4 variation effect on operating frequency shift is less for both OFF and ON conditions of the diode. But the impedance matching of the antenna is affected, the increment in W_4 dimension helped in improving the impedance matching. Based on the required operating frequencies for the considered 5G bands $W_4 = 9.5$ mm is considered for further analysis. For dimensions L_3 and L_4 of the operating frequency is being shifted drastically when these dimensions are varied. When L_3 is increased the operating frequency is being shifted towards the lower resonance while the impedance matching is affected less. But for increment in dimension L_4 not only the operating frequency is being shifted towards lower resonance, the impedance matching is improving. Based on the operating frequencies of n78 and n77 bands $L_3 = 3$ mm and $L_4 = 3$ mm are selected. Similarly rests of the dimensions in antenna geometry are varied and through parametric study the suitable dimensions that produced required operating frequencies are listed in Table [1].

4 Results and Discussions

The performance comparison for the PIN diode OFF and ON conditions are explained in this section using S_{11} vs frequency, VSWR, radiation patterns and surface current distribution field curves.

4.1 Reflection Coefficient Comparison for OFF and ON Conditions

The proposed antenna performance comparison for OFF and ON conditions using reflection coefficient curves is presented in the following Fig. 8. The designed 5G antenna operated at 3.5 GHz with operational band below -10 dB, covering from 3.34 GHz to 3.7 GHz (n78 band) for diode OFF condition. Similarly, it operated at 3.7 GHz with operational band covering from 3.47 GHz to 3.94 GHz (n77 band). So, the 5G antenna-maintained band widths of 360 MHz and 470 MHz for OFF and ON conditions respectively. The return loss for OFF condition at 3.5 GHz is maintained at -18.41 dB and for ON condition at 3.7 GHz the return loss is -33 dB.

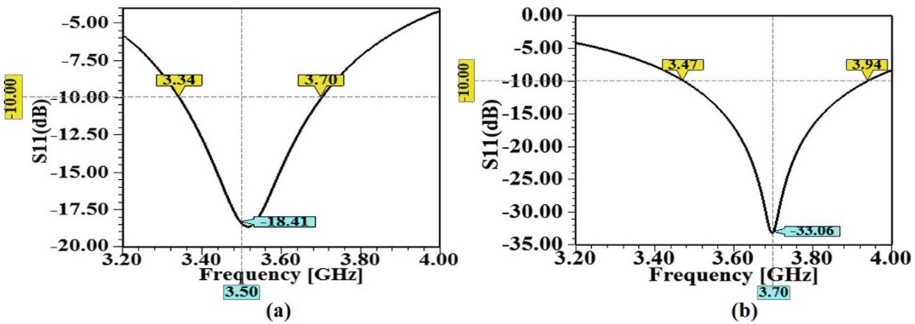

Fig. 8. S_{11} vs Frequency curves comparison a) Diode-OFF and b) Diode-ON

4.2 VSWR Comparison for OFF and ON Conditions

Similarly for diode OFF and ON conditions the VSWR curves comparison is presented in the following Fig. 9.

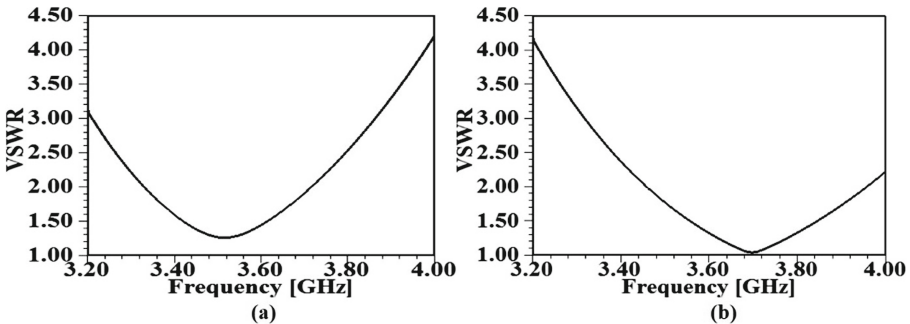

Fig. 9. VSWR curves comparison a) Diode-OFF and b) Diode-ON

From the above Fig. 9, it can be observed that the VSWR value for the proposed antenna maintained in between 1 and 2 values for the respective operational bands during OFF and ON conditions.

4.3 2D and 3D Radiation Patterns Comparison for OFF and ON Conditions

As the antenna resonant frequency maintained at 3.5 GHz for diode OFF condition and at 3.7 GHz for diode ON condition the radiation pattern comparison is given at the respective resonant frequencies in the below Fig. 10.

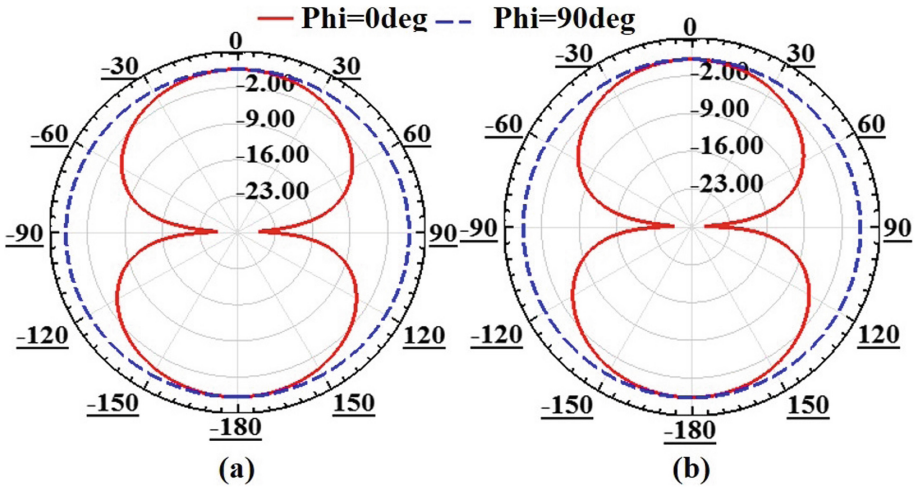

Fig. 10. 2D radiation pattern comparison a) At 3.5 GHz for Diode-OFF and b) At 3.7 GHz for Diode-ON

From Fig. 10 it can be seen that, the 5G antenna maintained similar radiation coverage for the diode OFF and ON conditions at its respective operating frequencies proving its suitability for 5G applications.

Similarly the 3D radiation patterns at 3.5 GHz and 3.7 GHz for OFF & ON conditions are compared in the following Fig. 11.

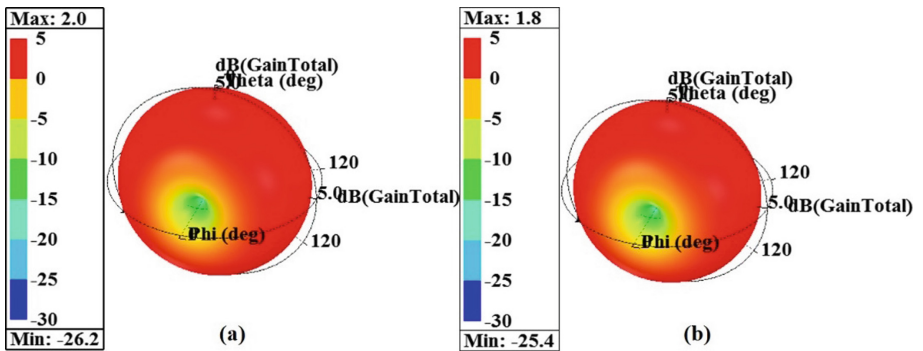

Fig. 11. 3D radiation pattern comparison a) At 3.5 GHz for Diode-OFF and b) At 3.6 GHz for Diode-ON

From the above Fig. 11 it can be observed that, the 5G antenna maintained similar shape for radiation coverage in overall. But the maximum gain during diode OFF condition is maintained at 2 dB at 3.5 GHz resonant frequency. Whereas for diode ON conditions the maximum gain is 1.8 dB at resonant frequency 3.7 GHz.

4.4 Surface Current Distribution Comparison for OFF and ON Conditions

The current distribution for respective resonant frequencies during diode OFF and ON conditions is presented in the following Fig. 12.

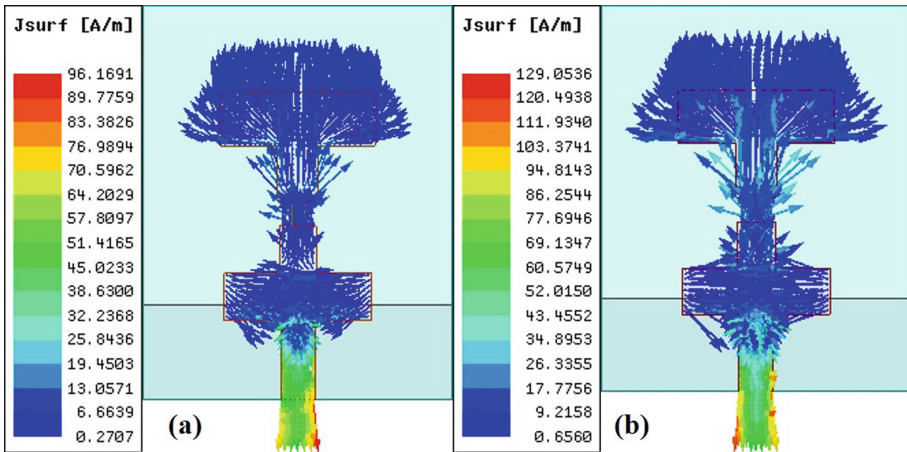

Fig. 12. Surface current distribution comparison a) At 3.5 GHz for Diode-OFF and b) At 3.7 GHz for Diode-ON

From the current distribution curves shown in above Fig. 11 it can be seen that at respective operating frequencies while the diode is OFF and ON the 5G antenna maintained different current distribution through the patch. For diode OFF condition the maximum J value at 3.5 GHz is 96.16 A/m and for ON condition it is 129.05 A/m at 3.7 GHz.

5 Conclusion

A frequency reconfigurable 5G antenna is designed and presented for n78 and n77 bands. The designed antenna covered n78 band operating at 3.5 GHz while the diode is OFF condition and maintained bandwidth of 360 MHz. Similarly for diode ON condition it serves 5G n77-band operating at 3.7 GHz with bandwidth of 470 MHz. Antenna exhibited good radiation coverage for both OFF and ON conditions making it good candidate for 5G applications.

References

1. Ojaroudi Parchin, N., Jahanbakhsh Basherlou, H., Al-Yasir, Y.I.A., Abdulkhaleq, A.M., Abd-Alhameed, R.A.: Reconfigurable antennas: switching techniques—a survey. *Electronics* **9**(2), 1–14 (2020)
2. Jayamani, K., Indhumathi, K., Jeevakumari, S.A.A.: A survey on frequency reconfigurable antennas using passive element for ISM band. In: 2020 IEEE 7th International Conference on Smart Structures and Systems (ICSSS), Chennai, India, pp. 1–3. IEEE (2020)
3. Boufrioua, A.: Frequency reconfigurable antenna designs using pin diode for wireless communication applications. *Wireless Pers. Commun.* **110**(4), 1879–1885 (2019). <https://doi.org/10.1007/s11277-019-06816-x>
4. George, R., Kumar, S., Gangal, S.A., Joshi, M.: Frequency reconfigurable pixel antenna with PIN diodes. *Progr. Electromagn. Res. Lett.* **86**, 59–65 (2019)
5. Chen, Y., et al.: Frequency reconfigurable circular patch antenna with an arc-shaped slot ground controlled by PIN diodes. *Int. J. Antennas Propag.* 1–7 (2017)
6. Sun, M., Zhang, Z., Zhang, F., Chen, A.: L/S Multiband frequency-reconfigurable antenna for satellite applications. *IEEE Antennas Wirel. Propag. Lett.* **18**(12), 2617–2621 (2019)
7. Qin, J., Fu, X., Sun, M., Ren, Q., Chen, A.: Frequency reconfigurable antenna based on substrate integrated waveguide for S-band and C-band applications. *IEEE Access* **9**, 2839–2845 (2021)
8. Yuan, Y., Sun, X., Zhang, Y., Zhao, L., Wang, Y.: Design of frequency reconfigurable antenna based on metasurface. In: 2021 7th International Conference on Computer and Communications (ICCC), pp. 2165–2169. IEEE (2021)
9. Hashim, Z., Gupta, N., Prakash, A., Tripathi, R.: Dual-band UWB bandpass filter with triangular DB-DGS for WLAN applications in DSRC band. *AEU-Int. J. Electron. Commun.* **86**, 77–85 (2018)
10. Gottapu, S.K., Vallabhaneni, P.: Wireless sensor network localization in 3D using steerable anchors' antennas. In: Conference on Signal Processing and Communication Engineering Systems (SPACES). IEEE (2018)
11. Ramahatla, K., Mosalaosi, M., Yahya, A., Basutli, B.: Multiband reconfigurable antennas for 5G wireless and CubeSat applications: a review. *IEEE Access* **10**, 40910–40931 (2022)
12. Ghaffar, A., Li, X.J., Seet, B.-C., Awan, W.A., Hussain, N.: Compact multiband frequency reconfigurable antenna for 5G communications. In: 29th International Telecommunication Networks and Applications Conference (ITNAC), pp. 1–3. IEEE (2019)
13. Ullah, S., et al.: A compact frequency and radiation reconfigurable antenna for 5G and multi-standard sub-6 GHz wireless applications. *Wirel. Commun. Mob. Comput.* **2022**, 12 (2022). Article ID 4658082
14. Rahayu, Y., Reyhan, M.S.F., Pradana, Y.B., Kurniawan, A.: Frequency reconfigurable 5G rectangular patch antenna. In: 26th IEEE Asia-Pacific Conference on Communications (APCC), pp. 19–22. IEEE (2021)
15. Chen, Y., Liu, Q., Zhang, Y., Li, H., Zong, W.: Design of a compact base station antenna for 5G N78-band application. In: IEEE 3rd International Conference on Electronic Information and Communication Technology (ICEICT), pp. 229–231. IEEE (2020)
16. Hassan, W.M., Ibrahim, K.M., Attiya, A.M.: MIMO antenna for N48, N77, N78 5G applications. *Progr. Electromagn. Res. C* **117**, 129–143 (2021)