



An Uplink OFDMA Access Method for Low Latency in Next-Generation WLANs

Qingsong Gao, Ding Wang, Mao Yang^(✉), Bo Li, and Zhongjiang Yan

School of Electronics and Information, Northwestern Polytechnical University,
Xi'an, China
{wangd, yangmao}@nwpu.edu.cn

Abstract. The next generation of wireless local area network (WLAN) standard: IEEE 802.11be takes ultra-high-definition video and ultra-low latency services as its core service bearer targets. Orthogonal frequency division multiple access (OFDMA) technology can improve the efficiency of multi-access, but the OFDMA protocol of the existing WLAN can only serve one user per resource unit in a transmission process, and the data between different users needs to be filled with invalid information bits (padding) to ensure the alignment of the transmission time. Padding creates a waste of resources and affects the latency characteristics of the business. This paper proposes an uplink OFDMA access method for low latency in the next generation of WLANs, allowing the wireless access point (AP) to divide OFDMA resource unit into multiple periods from time and assign each period to a station (STA) to transmit. The scheme can avoid the waste of resources and improve the response speed of user services. In this paper, the protocol flow and frame structure of this method are designed in detail to make scheme have good compatibility with IEEE 802.11ax. Simulation results show that the proposed scheme can significantly improve latency performance compared with IEEE 802.11ax.

Keywords: Wireless local area network (WLAN) · Orthogonal frequency division multiple access(OFDMA) · IEEE 802.11ax · Throughput

1 Introduction

With the demand of customer consecutively increasing, ultra-high-definition video services and real-time applications (RTAs) will be important parts in future wireless networks. IEEE 802.11be which is next-generation WLAN standard will guarantee ultra-high throughput and low-latency streams and make it to core service goals, which is the most important purpose of IEEE 802.11be [1]. IEEE 802.11be stands in a critical period for technical research supported, and the user's quality of service (QoS) is one of the important wireless key performance indicators(KPIs). IEEE 802.11be emphasizes ultra-high throughput and

ultra-low latency. The requirements for QoS and user experience have large-scale improvement. It adopts a larger bandwidth up to 320MHz, and allows non-continuous channels to be aggregated and coordinated work between multiple APs. Emergency preparedness communications service (EPCS) and restricted target wake-up time mechanism (r-TWT) guarantees low latency for the service [2,3]. At the same time, large-scale networking of overlapping basic set service (OBSS) [4] is an important trend for next-generation WLAN. OBSS will cause a lot of conflicts [5,6]. So how to improve QoS and ensure more STAs to access is the key research direction of next generation of WLAN multi-access technology [7,8].

Since AP is a unified source node to initiate transmission for downlink transmission, AP can ensure low latency characteristics relying on its strong channel access capabilities and scheduling capabilities. However the uplink transmission chance needs to be competed by each STA, thus uplink transmission delay protection is a challenging topic of vital importance. OFDMA can improve multiple access efficiency which is introduced in IEEE 802.11ax standard [2] at 2021 for the first time. The uplink OFDMA process based on AP scheduling can improve the uplink access efficiency to a certain extent, and in multi-user scenarios AP will send trigger frame (TF) firstly which destinations are STAs of the cell to indicate the specific allocation of channel resources. Then STA will set the initial time, channel, and length of packet, to maintain alignment according to the TF.

In order to improve the performance of the uplink OFDMA, a number of studies and algorithms have been proposed. The authors of the paper [9] proposed that using algorithm based on non-orthogonal multiple access (NOMA) to increase the accessed number of STA, and dividing resource units (RUs) to different groups. The scheduled RU made two STA access by NOMA. Remain RUs were assigned to fixed STA for random access which can reduce the probability of collisions and increase throughput of the system. S. Bhattacharai [10] proposed an optimal RU allocation algorithm, so AP need allocate as many scheduled RUs as possible to the STA in order to increase throughput. AP gave the optimal RU allocation scenarios based on the information in the Buffer State Report (BSR). Two kinds of up-link OFDMA random access (UORA) method were proposed by E. Avdotin and D. Bankov [11]. First algorithm allocated part of RUs to STAs by scheduling in the case of insufficient RUs, and the second scheduling was assigned to the subsequent STAs until all the STAs were fully allocated. The second algorithm grouped the STAs for loop in the Basic Service Set (BSS) and assigned RUs to each group. If a collision happened in an RU, STAs in the group would be round-robin again until no collision happened. Yang A. [12] proposed a grouping-based UORA algorithm. AP decided on grouping firstly, then AP calculated the utilization rate and maximized the utilization rate to achieve UORA improvement through the algorithm.

However, there is a common problem in existing research: the OFDMA protocol of the existing WLAN can only serve one user per RU during a transmission, and package needs to be filled with invalid information bits (padding) to ensure that the transmission time is aligned. S. Kim and J. Yun [13] made research on

the setting of UpLinkLength. While dynamically adjusting the UpLinkLength can only allow a STA access in a RU, it still needs to fill package by padding quite a bit, which causes a waste of resources and affects latency performance of the stream.

Aiming at the problems of resource waste and poor latency guarantee of the existing WLAN uplink OFDMA protocol, this paper proposes an uplink OFDMA access method for low latency in the next generation of WLAN. The access method allows the wireless AP to divide OFDMA resource unit into multiple time periods of UpLinkLength, and each period is assigned to a STA for transmitting, which avoids the waste of resources and improves the response speed of STA services. In this paper, the protocol flow and frame structure of this method are designed in detail to make it have good compatibility. Simulation results show that the proposed method can significantly improve the latency performance and throughput performance compared with the resource allocation in 802.11ax.

The remainder of this paper is organized as follows. In Sect. 2, the traditional OFDMA access principle is analyzed and the possible problems are given. Section 3 builds a system model. Section 4 describes the protocol for low-latency OFDMA and gives several implementations. Mathematical analysis is given in the Sect. 5. The results are parsed and analyzed in Sect. 6. The paper is summarized in Sect. 7.

2 Uplink OFDMA Access Principle and Problem Analysis in WLAN

2.1 OFDMA Access Principle in IEEE 802.11ax

In the IEEE 802.11ax standard [2], MAC protocol allows multi-user to access simultaneously by OFDMA. The given bands 20 MHz, 40 MHz, 80 MHz and 160 MHz are divided into smaller frequency bands, these resource blocks are orthogonal to each other which is unified allocated by AP. User accesses channel according to the divided channel and subcarrier. OFDMA transmission can be divided into uplink and downlink. During the downlink transmission, AP knows all the buffered information and places this information in traffic indication message (TIM). STAs of the BSS are informed whether there are packets that need to be received through Beacon frames.

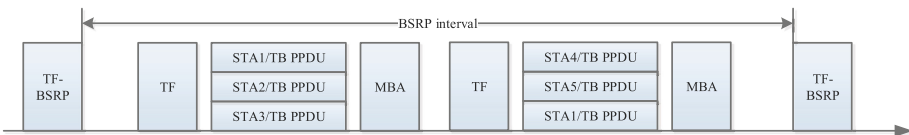

Fig. 1. Schematic diagram of the traditional OFDMA access principle.

During the uplink transmission, the AP doesn't get the specific cache information, thus AP can choose to send a buffer state report polling (BSRP) frame to require that STAs reply BSR frame to report all its cache information. As shown in Fig. 1, AP sends TF after collecting the cache packet informations, then STA1, STA2 and STA3 reply trigger-based PLCP protocol data unit (TB PPDU), AP responds multi-block ack (MBA) which marks that a scheduled transmission ends. STA is primarily based on two access methods, one of them is the AP's own scheduling algorithm, which allocates RU resource blocks to the STA. Since BSRP is sent periodically, AP can't get the buffer information in time for some low-latency stream. Thus there is an another access method that is random access by STA [14]. The AP will set the RU's association identifier (AID) to zero. At this time, the STA with low latency stream will selected the RU randomly which AID set to 0 to ensure transmission of low latency stream [15].

2.2 Analysis of OFDMA Access Problems

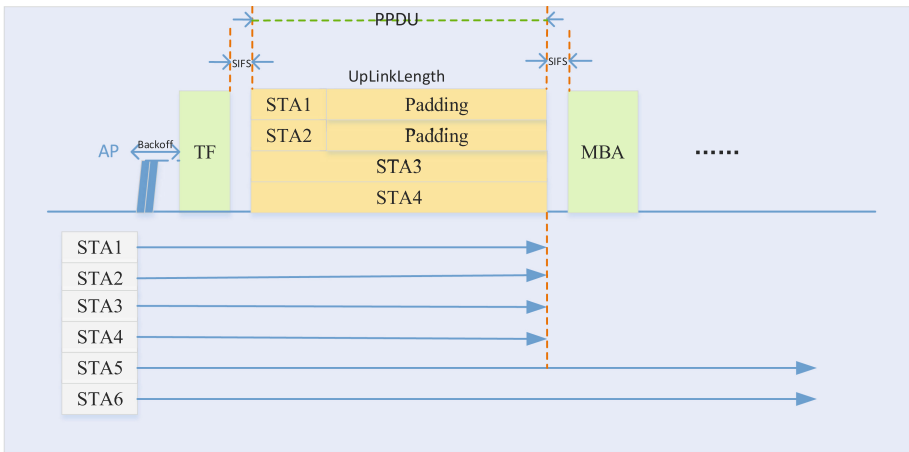

Fig. 2. Analysis of the 802.11ax uplink OFDMA.

In order to ensure the alignment of time in receiving terminal, AP will set transmit time (UpLinkLength) for each STA no matter which access method is adopted when using traditional OFDMA access scheme. Spec stipulates that STA must ensure that its duration is strictly aligned during the uplink transmission as shown in Fig. 2. STA3 and STA4 are scheduled to fill up the time for transmitting without padding during the scheduled transmission. Many STAs choose to take padding to supplement TB-PPDU because of the different sizes of STAs' performed packets [13, 16]. Due to packets of STA1 and STA2 can't fulfill the entire uplink length, it is necessary to use padding to make time aligned. Consequently STA5 and STA6 cannot get the transmission opportunity, and

must wait for the next scheduled transmission at least. It will cause a larger delay. Therefore how to reasonably arrange the use of padding has become an important issue in the uplink OFDMA access scheme [17].

3 System Model

Without loss of generality, we consider the basic system model of the WLAN based on 1 AP and n STAs within a BSS:

$$N = \{N_1, N_2, N_3, \dots, N_n\} \quad (1)$$

To simplify the process, AP send TF to schedule STA directly, and the delay of system refers to the average delay per packet:

$$T_D = \frac{\sum_1^{N_p} T_T}{\sum_1^n P_T} \quad (2)$$

where T_D denotes the average delay of each packet, N_p represents the number of packets sent, T_T denotes the packet delay of each successful transmission, and P_T means the packet that is successfully transmitted. This article assumes that arrival of system packets follows Poisson distribution. Table 1 shows the meaning of parameters.

Table 1. Simulation parameter table.

Parameter	Meaning
T_s	SIFS duration.
T_{sl}	Slot time.
T_A	AIFS.
T_{UL}	The length of the uplink transmission.
T_{MBA}	Multi-Block ACK duration.
T_b	Backoff duration.
T_{TF}	TF duration.
S	Package size.
N_{ru}	Total number of RUs.
R_o	20M/40M RU number in IEEE 802.11ax.
R_s	Number of shared RUs.
P_s	Package production rate.

4 Description of the Uplink OFDMA Protocol for Low Latency

4.1 Protocol Overview

As shown in Fig. 2, it can be seen that the subsequent transmission packets are fulfilled with padding when the number of cache packets of STA1 and STA2 is in shortage in IEEE 802.11ax scheme. STA5 and STA6 cannot access channels in this TF transmission.

Therefore, we propose an enhanced RU allocation scheme as shown in Fig. 3. After AP got the buffer information of STA, we divide RUs into smaller resource blocks on partial RUs, allowing more STA to transmit compared with the resource division method in IEEE 802.11ax. At which point STA5 and STA6 don't need to wait for the next TF scheduling which can effectively reduce the delay. AP scheduling algorithm is not covered by this article, whereas the AP scheduling should be reasonably arranged according to the urgency of STAs' packet. Thus we don't make more discussion here. In IEEE 802.11ax standard, bandwidth is divided dynamically. The allocation of shared RU and length of UpLinkLength can also be dynamically allocated.

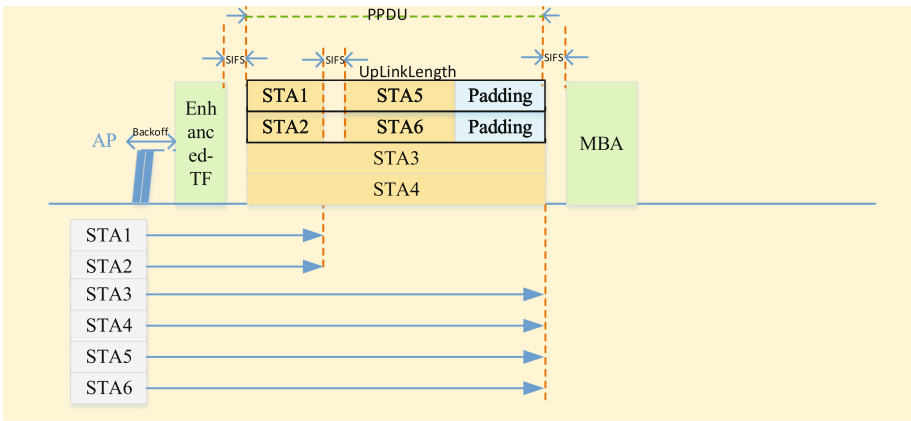

Fig. 3. Proposed uplink OFDMA protocol design.

4.2 Protocol Design

When designing the frame structure, it is necessary to specify the length of UpLinkLength for each STA and inform STA the beginning time. There are zero or more User Info Fields in Linked List Field. Each user has a separate information field followed by IEEE 802.11ax standard [2] where a User Info List Field exists. Therefore we use those fields to indicate that the STA is sent firstly (Former STA) in a RU during the uplink transmission, or sent secondly (Later STA), or occupies the entire RU block without sharing.

Considering specific operation and less payload, two implementations are given as following:

- (1) As shown in Fig. 4, the UpLinkLength of Former STA and Later STA are specified under this scenario. The transmission duration of former STA is $\frac{1}{2}T_{UL}$, and the transmission duration of Later STA is calculated by:

$$T_L = \frac{1}{2}T_{UL} - T_s \tag{3}$$

Starting time of Later STA is given as:

$$T_{ST} = \frac{1}{2}T_{UL} + T_s \tag{4}$$

The time of entire orthogonal RU block is aligned. Implementation1 modifies the original B39 field to Shared RU, indicating that the RU is a shared RU. Then STA reads B40 field. It means that the STA is a Former STA if Station Location field is set to 1. Or else, it means that the STA is a Later STA. In which case STA can determine its duration and beginning time of sending according to above provisions. STA don't need to modify subfield supposed that it's allocated a monopoly RU. The overhead is 8 bits in this scenario.

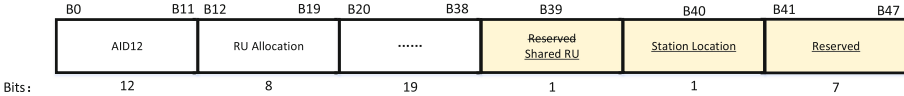

Fig. 4. User Info Field Format implementation1.

- (2) As shown in Fig. 5, a new Special UpLinkLength (SU) field is added under this scheme. At this point, the uplink transmission duration of the Former STA can be denoted by T_{SU} , and the transmission duration of the Latter STA is calculated by:

$$T_L = T_{UL} - T_{SU} - T_s \tag{5}$$

Starting time of Later STA is given as:

$$T_{ST} = T_{SU} + T_s \tag{6}$$

This implementation has greater flexibility, which facilitates the scheduling of AP more reasonably in duration. The additional overhead for this scenario is 16bits.

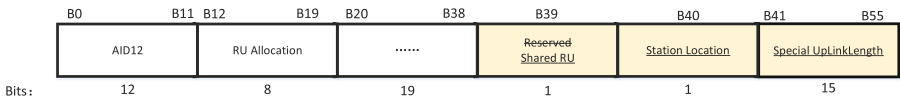

Fig. 5. User Info Field Format implementation2.

5 Theoretical Performance Analysis

The first STA position st for which no transmission opportunity was obtained in the m th transmission can be calculated as:

$$st = 1 + (mN_{ru}) \bmod (n), \quad n < N_{ru} < 2n \quad (7)$$

where the number of RUs is N_{ru} .

The STA set R that don't get a transmitting opportunity in the m th transmission can be formulated as:

$$R = \begin{cases} \{N_{st}, \dots, N_{st+n-N_{ru}}\}, & st + n - N_{ru} \leq n \\ \{N_{st}, \dots, N_n, N_1, \dots, N_{st-N_{ru}}\}, & st + n - N_{ru} > n \end{cases} \quad (8)$$

In conjunction (1)(8), it can be known that the STA set B that gets the transmission opportunity is as following:

$$B = N - R \quad (9)$$

According to the M/M/s queuing model [18], it can be known that:

$$\rho = \frac{\lambda}{\mu} \quad (10)$$

$$\rho_s = \frac{\lambda}{s\mu} \quad (11)$$

$$p_k = \begin{cases} \frac{\rho^k}{k!} p_0, & k = 1, \dots, s-1, \\ \frac{\rho^k}{s!s^{k-s}} p_0, & k \geq s, \end{cases} \quad (12)$$

$$ES = \frac{p_0 \rho \rho_s}{s!(1-\rho_s)^2} + \frac{1}{\mu} \quad (13)$$

where λ means the rate of user arrival. μ denotes the rate of service for service desk. s means the number of service desks, namely N_{ru} in this system. ρ indicates the utilization rate of system single service desk. ρ_s manifests the total utilization rate of the system multi-service desk. p_k represents the number of customers in system. The user's remain time in system is ES , namely, average latency per packet.

Implementation1 is used for analysis for simplifying calculation. Packets arrive in bulk and batch out under this model. Combined (7)(8)(9), and the service rate of system's service desk μ is obtained by:

$$\mu = \frac{1}{\frac{2n-2N_{ru}}{n} \times 2T + \frac{2N_{ru}-n}{n} \times T} \quad (14)$$

where T is the total duration of a service and is calculated as follows:

$$T = T_b + T_{TF} + 2T_s + T_A + T_{UL} + T_{MBA} \quad (15)$$

where the calculation of T_A is shown in Eq. (16).

$$T_A = T_s + 2T_{st} \quad (16)$$

Packets are batch in, batch out. We introduce the aggregation of degree A , the number of packets that can be served per transmission is calculated as:

$$A = \frac{\frac{P_s}{8S} \times n}{\mu N_{ru}} = \frac{nP_s}{8\mu SN_{ru}} \quad (17)$$

The rate of packet arrival can be expressed as the degree of aggregation of the total number of packages, as shown in formula (18):

$$\lambda = \frac{\frac{P_s}{8S} \times n}{A} = \mu N_{ru} \quad (18)$$

Combined formula (13)(14)(18), the average packet latency ES of the system T_D can be calculated as:

$$ES = \frac{1}{\mu} + T_f - T_a \quad (19)$$

where T_f denotes the average arrival time in a transmission before aggregation, T_a denotes the average arrival time in a transmission after aggregation which can be calculated by formula (17).

The total throughput Q of the system can be expressed as:

$$Q = \frac{N_p S}{T} \quad (20)$$

6 Performance Evaluation

6.1 Simulation Environment and Parameter Settings

We take integrated system & link level simulation platform [19,20] to build IEEE 802.11ax simulation platform, which is performed in one BSS simulation scenario, and the position of the STA is random. The simulation parameters are shown in Table 2.

6.2 Simulation Results and Analysis

The simulation results shows the comparison of throughput and latency between different scenarios at 20 MHz and 40 MHz, respectively.

(1) The package production rate increases

The number of shared RU is fixed to 5, the number of STA is fixed to 18, and the package rate of each STA increasing gradually from 1 to 6 in units of 500 kbps at this time. All useful RUs can be calculated as follows:

$$N_{ru} = R_o + R_s \quad (21)$$

Table 2. Simulation parameter value table.

Parameter	Value
T_s	16 ms
T_{sl}	9 μs
T_A	SIFS + 2*Slot time
T_{UL}	4 ms
T_{MBA}	84 μs
T_b	15 μs
T_{TF}	64 μs
S	200Bytes
N_{ru}	9/10(20M/40M)
R_o	20M/40M RU number in IEEE 802.11ax
R_s	5
P_s	2 Mbps

By looking up the table [2], the limiting throughput $Q_{h26-tone}$ of 26-tone is 10.0 Mbps at an MCS rate of nine and an NSS rate of one. Because of interaction of control frames in the system, and preamble packet size which is 36 bytes, limit throughput can be calculated of the system in 20 M bandwidth:

$$Q_h = R_o Q_{h26-tone} \frac{T_{UL} S}{T(S + S_p)} \tag{22}$$

The maximum throughput Q_h is 73.5 Mbps, thus BSS has not reached the full payload through comparison in simulation scene.

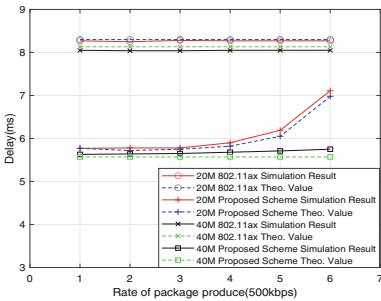

Fig. 6. Impact of different rate on delay performance

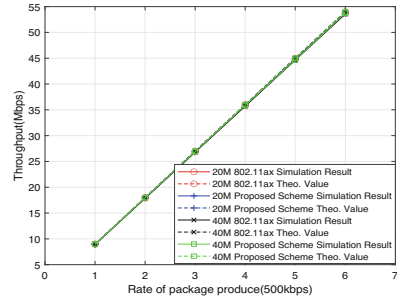

Fig. 7. Impact of different rate on throughput performance

The simulation results are shown in Fig. 6 and Fig. 7, and in the case of the same bandwidth of 20M or 40M, the improvement of delay performance is more

obvious after using proposed scheme compared with IEEE 802.11ax scheduling scheme [2]. When there are more STAs, the implementation of this scheme can significantly improve performance of delay. So that more stations can access the transmission in time without waiting for the next TF schedule.

(2) STA increases

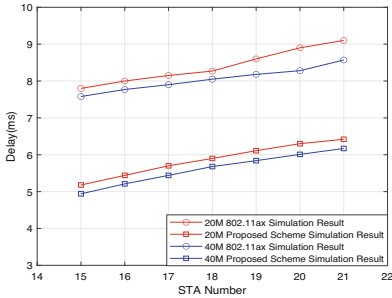

Fig. 8. Impact of STA number on delay performance

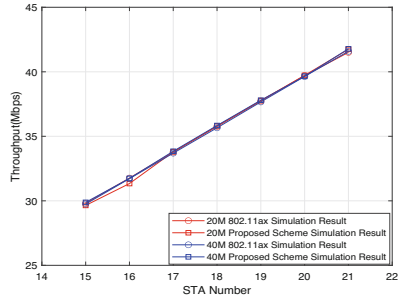

Fig. 9. Impact of STA number on throughput performance

It can be seen that this solution make more STAs access from Fig. 8 and Fig. 9, which can effectively reduce the delay of packet and ensure low latency transmission of the STA with the change of number of STAs.

7 Conclusion

In order to improve the delay performance of the IEEE 802.11ax access methods in next generation WLAN, this paper proposed an uplink OFDMA access method for low latency in next generation WLAN. It can be seen that the enhanced access method can effectively reduce the system delay and make more STAs access by improving the traditional uplink transmission. Frame structure of the scheme is designed in detail and then verified by simulation. This paper provides two frame structure designs, giving AP flexible allocation when minimizing signaling overhead. The access method designs simply and has little overhead, it provides a solution for the next generation of WLANs for low latency and high throughput and has a good compatibility with spec.

Acknowledgments. This work was supported in part by the National Natural Science Foundations of CHINA (Grant No. 61871322, No. 61771392, and No. 61771390), and Science and Technology on Avionics Integration Laboratory and the Aeronautical Science Foundation of China (Grant No. 20185553035 and No. 201955053002).

References

1. Levitsky, I., Okatev, Y., Khorov, E.: Study on simultaneous transmission and reception on multiple links in IEEE 802.11be networks. In: 2020 International Conference Engineering and Telecommunication (En & T), pp. 1–4 (2020). <https://doi.org/10.1109/EnT50437.2020.9431275>
2. IEEE standard for information technology-telecommunications and information exchange between systems local and metropolitan area networks-specific requirements part 11: wireless LAN Medium Access Control (MAC) and Physical Layer (PHY) specifications amendment 1: enhancements for high-efficiency WLAN. In: IEEE Std 802.11ax-2021 (Amendment to IEEE Std 802.11-2020), pp. 1–767 (2021). <https://doi.org/10.1109/IEEESTD.2021.9442429>
3. Chen, Q., Weng, Z., Xu, X., Chen, G.: A target wake time scheduling scheme for uplink multiuser transmission in IEEE 802.11ax-based next generation WLANs. In: IEEE Access, vol. 7, pp. 158207–158222 (2019). <https://doi.org/10.1109/ACCESS.2019.2950464>
4. Lanante, L., Roy, S.: Performance analysis of the IEEE 802.11ax OBSS_PD-Based Spatial Reuse. In: IEEE/ACM Transactions on Networking. <https://doi.org/10.1109/TNET.2021.3117816>
5. Zhong, Z., Kulkarni, P., Cao, F., Fan, Z., Armour, S.: Issues and challenges in dense WiFi networks. In: International Wireless Communications and Mobile Computing Conference (IWCMC), vol. 2015, pp. 947–951 (2015). <https://doi.org/10.1109/IWCMC.2015.7289210>
6. Yin, B., Kamiya, S., Yamamoto, K., Nishio, T., Morikura, M., Abeysekera, H.: Starvation mitigation for dense WLANs through distributed channel selection: potential game approach. In: 2017 14th IEEE Annual Consumer Communications & Networking Conference (CCNC) (2017), pp. 548–553. <https://doi.org/10.1109/CCNC.2017.7983166>
7. Zhao, X., Lei, L., Li, Z.: Modeling and analyzing per-flow saturation throughput for wireless Ad Hoc networks with directional antennas. In: 2018 IEEE 3rd International Conference on Cloud Computing and Internet of Things (CCIOT), pp. 94–97 (2018). <https://doi.org/10.1109/CCIOT45285.2018.9032679>
8. Lee, J., Lee, H., Yi, Y., Chong, S., Knightly, E.W., Chiang, M.: Making 802.11 DCF near-optimal: design, implementation, and evaluation. IEEE/ACM Trans. Networking **24**(3), 1745–1758 (2016). <https://doi.org/10.1109/TNET.2015.2432053>
9. Lee, W.-J., Shin, W., Ruiz-de-Azua, J.A., Capon, L.F., Park, H., Kim, J.-H.: NOMA-based uplink OFDMA collision reduction in 802.11ax networks. In: 2021 International Conference on Information and Communication Technology Convergence (ICTC), pp. 212–214 (2021). <https://doi.org/10.1109/ICTC52510.2021.9621014>
10. Bhattarai, S., Naik, G., Park, J.-M.J.: Uplink resource allocation in IEEE 802.11ax. In: ICC 2019–2019 IEEE International Conference on Communications (ICC), pp. 1–6 (2019). <https://doi.org/10.1109/ICC.2019.8761594>
11. Avdotin, E., Bankov, D., Khorov, E., Lyakhov, A.: Enabling massive real-time applications in IEEE 802.11be networks. In: 2019 IEEE 30th Annual International Symposium on Personal, Indoor and Mobile Radio Communications (PIMRC), pp. 1–6 (2019). <https://doi.org/10.1109/PIMRC.2019.8904271>
12. Yang, A., Li, B., Yang, M., Yan, Z., Xie, Y.: Utility optimization of grouping-based uplink OFDMA random access for the next generation WLANs. Wireless Netw. **27**(1), 809–823 (2020). <https://doi.org/10.1007/s11276-020-02489-8>

13. Kim, S., Yun, J.: efficient frame construction for multi-user transmission in IEEE 802.11 WLANs. *IEEE Trans. Veh. Technol.* **68**(6), 5859–5870 (2019). <https://doi.org/10.1109/TVT.2019.2907281>
14. Yang, A., Li, B., Yang, M., Yan, Z.: Group-based uplink OFDMA random access algorithm for next-generation WLANs. *JNWPU* **38**(1), 155–161 (2020). <https://doi.org/10.1051/jnwpu/20203810155>
15. Kosek-Szott, K., Domino, K.: An efficient backoff procedure for IEEE 802.11ax uplink OFDMA-based random access. *IEEE Access* **10**, 8855–8863 (2022). <https://doi.org/10.1109/ACCESS.2022.3140560>
16. Lin, C.-H., Chen, Y.-T., Lin, K. C.-J., Chen, W.-T.: acPad: enhancing channel utilization for 802.11ac using packet padding. In: *IEEE INFOCOM 2017 - IEEE Conference on Computer Communications*, pp. 1–9 (2017). <https://doi.org/10.1109/INFOCOM.2017.8057127>
17. Dutta, A., Gupta, N., Das, S., Maity, M.: MMRU-ALLOC: an optimal resource allocation framework for OFDMA in IEEE 802.11ax. In: *2020 IEEE 31st Annual International Symposium on Personal, Indoor and Mobile Radio Communications*, pp. 1–6 (2020). <https://doi.org/10.1109/PIMRC48278.2020.9217154>
18. Tang, J.S.: *Queuing Theory and Its Applications*. Science Press, Beijing (2016)
19. Qu, Q., et al.: Survey and performance evaluation of the upcoming next generation WLANs standard - IEEE 802.11ax. *Mobile Netw. Appl.* **24**(5), 1461–1474 (2019). <https://doi.org/10.1007/s11036-019-01277-9>
20. Zhang, K.: Research on channel modeling and interference abstract simulation for next-generation WLANs. Master's thesis of Northwestern Polytechnical University. 2020.04