

Cognitive Radio Systems for Heterogeneous and Spectrum Sharing Type Wireless Network Managements

Kentaro Ishizu, Homare Murakami, Hiroshi Harada

Wireless Network Research Institute

National Institute of Information and Communications Technology (NICT)

Yokosuka, Japan

Abstract—This paper clarifies necessity of cognitive radio systems (CRSs) and introduces two approaches for their realization; heterogeneous type and spectrum sharing type. Both types of the CRSs have been developed for verification and evaluation. Large part of their design has been adopted as IEEE 1900.4. The systems are currently operated in a city-size test-bed for practical verifications. In the exhibition of CrownCom2011, the two types of CRSs are demonstrated.

Keywords—cognitive radio system; heterogeneous wireless network; spectrum sharing; cognitive wireless router; prototype; standardization

I. INTRODUCTION

As a result of tight and exhaustive assignment of frequency bands, it is urgent to establish a way forward to increase spectrum utilization efficiency in order to accommodate emerging new radio systems and potential huge traffic caused by increasing number of users and terminals with variety of applications. The cognitive radio technologies are expected to improve the spectrum utilization efficiency by reducing radio interferences between radio devices and utilizing appropriate radio systems and/or frequency bands including unused frequency bands in a flexible manner.

The cognitive radio systems (CRSs) are categorized into two types according to their approaches; heterogeneous type and spectrum sharing type [1]. The heterogeneous type CRS is a system which selects appropriate radio systems and/or operational frequency bands intelligently in order to increase utilization efficiency of existing radio systems. The spectrum sharing type CRS is a system which finds unused frequency bands for its operation in order to increase frequency utilization efficiency of whole potential frequency range. These two types of CRS should be integrated in terms of system architecture and management logics for further improvement of performance and flexibility of wireless communications.

For feasibility study and practical deployment of the CRSs, developments of systems which can be operated in real fields are expected. Therefore, NICT has developed both types of the CRSs and conducted evaluations from multiple points of view. For the heterogeneous type CRS, cognitive wireless router (CWR) system was developed [2-4]. For the spectrum sharing type CRS, a set of cognitive base station (CBS) and cognitive terminal (CT) was developed [5,6]. The CBS operates on unused frequency. The CT detects existence of radio systems,

identify kind of the systems, and reconfigure themselves to access the CBS.

International standardizations of specifications based on new technologies are effective to expand the corresponding market. System architecture, functions, and information model of cognitive wireless networks have been contributed, based on the developed CRSs, to establish IEEE 1900.4 standard published in February 2009, which is the world's first specification for fundamental architecture of heterogeneous type cognitive radio network [7-9]. The efforts are also being contributed to establish IEEE 1900.4a, which is an amendment of IEEE 1900.4 to extend its scope for spectrum sharing type cognitive radio network. As the developed CRSs are largely referred in the contributions to IEEE 1900.4, it is true that the CRSs are the world's first system conforming to this standard. In addition to IEEE 1900.4, NICT has also been contributed actively to ITU-R WP1B/WP5A and ETSI Reconfigurable Radio System (RRS) based on its developments of CRSs. Therefore, at this moment, it is significantly meaningful to verify the behavior and evaluate the performance.

This paper designs CRSs for both heterogeneous type and spectrum sharing type, details the prototype systems, and discusses their measurements. This paper also describes activities for IEEE P1900.4a standardization, to which designs of the CRSs have been contributed, and verification study of the heterogeneous type CRS on city-size test-bed currently operated in Fujisawa city [10].

II. HETEROGENEOUS TYPE COGNITIVE RADIO SYSTEM

The CWR system [2-4] is composed of CWRs and its manager called Network Reconfiguration Manager (NRM) server as shown in Fig. 1. The CWRs accommodate one or more off-the-shelf radio devices to access to the Internet. The CWRs act as an IEEE 802.11a/b/g access point for its local network so that the terminals on the local network can access to the Internet via the CWRs. The CWRs are connected to the Internet using one of the radio devices and conducts the NAT routing between the Internet and the local network.

The CWRs sense its operational frequency bands and provide the sensing information to the NRM server. The NRM server collects measurements on CWRs, analyzes them, and provides the terminals with policies. The policy provides the CWRs with instructions and/or recommendations on selecting the radio devices and/or their parameters. The CWRs are dynamically reconfigured according to the policy received

from the NRM server.

Two kinds of heterogeneous type CRSs have been developed as shown in Figure 2. The one is for fixed use with many device slots such as USB and CF. The other is for mobile use with battery to run for 4 hours.

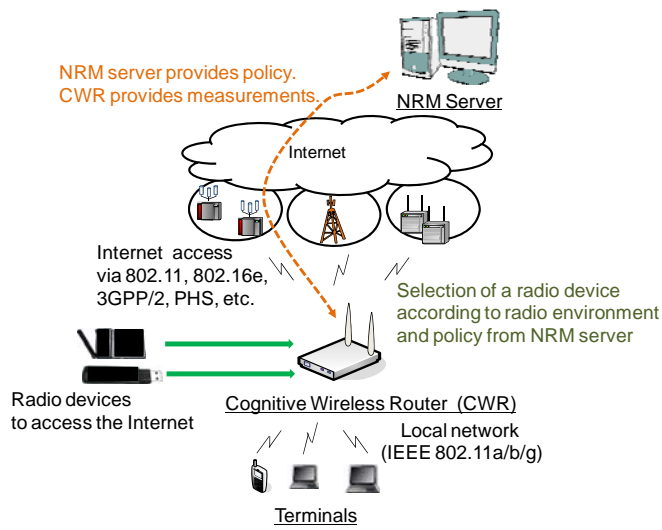

Figure 1. System configuration of the CWR system



Figure 2. Heterogeneous type CBS for fixed use (left) and mobile use (right)

III. SPECTRUM SHARING TYPE COGNITIVE RADIO SYSTEM

The spectrum sharing type CRS is composed of CBS and CT. They are able to conduct sensing on frequency bands from 400MHz to 6GHz, which are useful frequency bands for mobile communications, to detect existence of other radio system by received power and identify type of radio system [5,6]. They are also capable of reconfiguration of their own frequency, PHY/MAC, and its parameters. By this capability, the CBS finds unused frequency bands and operate on the frequency. The CT detects the CBS and reconfigures itself to establish connection with the CBS.

The CBS is composed of CPU board, FPGA board, RF board, and display board as shown in Fig. 3. The CT is

composed of the same boards. The CPU board analyzes measurements, user's preferences, and operation policies received from network side, and makes decision on reconfiguration. The FPGA board loads a waveform specified by the CPU board from multiple waveforms implemented and executes it. Waveform is a set of logic described by software to conduct baseband processing and MAC processing. Waveforms are accumulated in memory bank of the FPGA board in units of system specification like IEEE 802.11a, 802.16e, digital TV, PHS (Personal Handy-phone System). The RF board has a multi-band transceiver circuit.

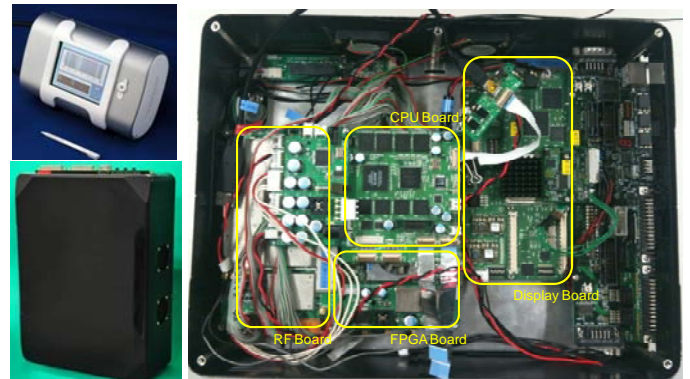

Figure 3. Spectrum Sharing type CBS composed of CT (upper) and CBS (bottom) and hardware configuration of CBS (right)

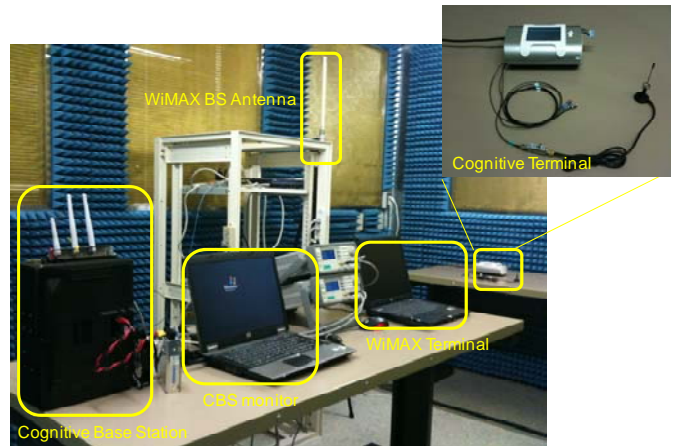

Figure 4. Experiment environment of spectrum sharing type CBS

IV. INTERNATIONAL STANDARDIZATIONS

In order to promote industries internationally based on research achievements, developed technologies should be standardized. NICT has been contributed to standardizations of the cognitive radio technologies. One of the standardizations related to cognitive radio technologies is IEEE 1900.4 [7-9] published in February 2009, which aims to improve overall composite capacity and quality of service of wireless systems in a multiple radio access technologies environment by defining appropriate system architecture and protocols. Since the scope of IEEE 1900.4 is within the heterogeneous type CRS, IEEE P1900.4a was established in March 2009 to

standardize amendment of IEEE 1900.4 for extending its scope to spectrum sharing type CRS. As of April 2011, IEEE 1900.4a is in the final step of its publishing process.

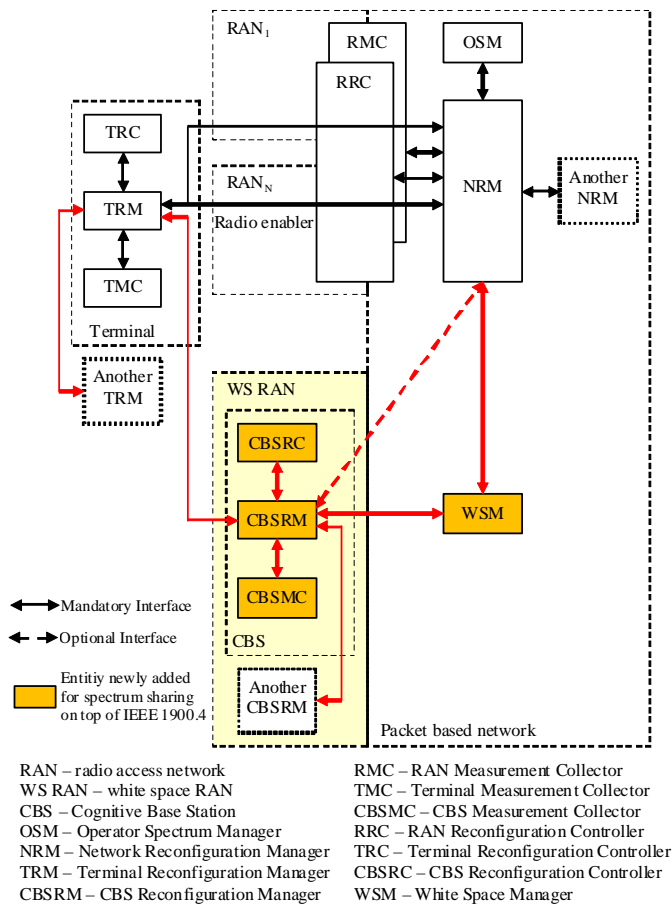

Figure 5. System architecture of IEEE P1900.4a draft standard

The system architecture discussed in IEEE P1900.4a is shown in Fig. 5. CBS Reconfiguration Manager (CBSRM), CBS Reconfiguration Controller (CBSRC), CBS Measurement Collector (CBSMC), and White Space Manager (WSM) are newly added on top of the IEEE 1900.4 system architecture. CBS are capable of communicating with NRM via WSM so that the heterogeneous type and spectrum sharing type CBSs are cooperatively coexist for efficient spectrum utilization. WSM is in charge of managing white space database and interfacing NRM and CBSRM.

V. PRACTICALITY VERIFICATION

Verification of the CRSs for practical utilization is essential for commercialization. Since the heterogeneous type CRS is closer to its commercialization compared with the spectrum sharing CRS which requires radio regulations that are not available now in Japan [10], NICT has setup a test-bed as the final research step of the heterogeneous type CRS.

Overview of the test-bed is shown in Figure 6. Five hundred CWRs are deployed around Fujisawa city. The management network composed of NRMs and other supporting servers for the test-bed are set up in the laboratory of NICT at Yokosuka Research Park (YRP) in Kanagawa, Japan. The management network is connected to the Internet via NICT's backbone network.

Out of 500 CWRs deployed in the testbed, 416 are in Fujisawa city, 73 are in Chigasaki city, 10 are in Yokosuka city and 1 in Samukawa town. Chigasaki city and Samukawa town are next to Fujisawa city. The Fujisawa city has 69.51 km² of the gross area and 170 thousands of population. The cities and town are within commuting distance to the Tokyo metropolitan area by trains. Thus, the test-bed is operated in a typical residential area of populated area of Japan.

The CWRs are set up in various locations including universities, museum, restaurants, sport facilities, hospitals, shopping malls, and community centres. About 400 CWRs are indoor and the others are outdoor. Outdoor CWR are covered by water-proof and plastics boxes which radio waves penetrate as shown in Figure. 7.

The management system is composed of 4 NRMs, 2 authentication servers, 2 NRM database servers, 2 authentication database servers, 2 web servers, 2 mail servers, a monitoring server, 2 load balancers, 2 firewalls, 2 routers and switches. The system is installed in four server racks as shown in Figure. 8. The authentication servers give permissions for CWRs to allow their terminals to access the

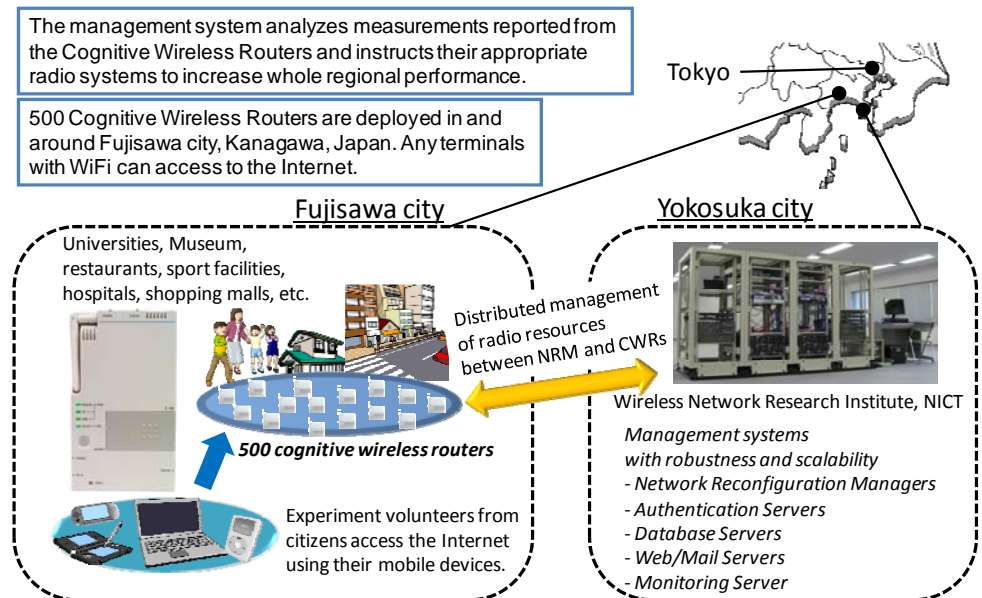

Figure 6. City-size cognitive radio test-bed with 500 CWRs

Internet if a set of username and password that are entered from the terminals via an HTTP interface provided on the CWRs matches with any of registered sets of username and password. Web servers are to provide operational information and registration method to users. The users need to register in advance through a web page in the web servers. The mail servers are to send accounting information to users if they register or change registered information such as password. The monitoring server is to check the status of each node in the management network by ICMP, SNMP, monitoring of TCP/UDP ports in use, and system resources monitoring. Administrators are notified by web interface and e-mails in case when unusual status is detected. Figure. 9 shows a screen shot of the operation software of the management system.

Redundancy of NRMs, authentication servers, and web servers are for fault tolerance, for which the load balancers distribute incoming messages. The mail servers are composed of a primary mail server and a secondary mail server within the framework of the SMTP specification, which is also for the purpose of fault tolerance. Redundancy of NRM database servers, authentication database servers and load balancers are composed of an active node and a standby node which exchange health check messages periodically and the standby node takes over the active node when the active node fails. The routers and firewalls are also organized redundantly using Virtual Router Redundancy Protocol (VRRP) where there are an active router and a standby router and the standby router takes over the active router when the active router fails to continue its operation. Switches are configured to use the Spanning Tree Protocol (STP) also for robustness.

Currently, various algorithms to manage the CWRs are developed such as optimized radio system selections using neural network optimization techniques. The algorithms are implemented using the open APIs of the management system and under verification using various measurements including traffic amount, connection number, and RSSI.

The CWRs are applicable to much more serious scenarios. On March 11 2011, east coast of Tohoku area in Japan was tremendously damaged by earthquakes followed by Tsunami waves with few equals in recorded history. Buildings such as houses, city halls, and schools and almost anything including breakwaters made from concrete are swept away. After the disaster, people are living in shelters but they have quite limited ways to obtain information because wired internet connections are not available due to damages in central systems and/or fibre disconnections. Some disaster countermeasures headquarters and hospitals also have no connections to the Internet as of one month later of the disaster and were experiencing difficulties in their operations. As even cellular based systems were partly unavailable, cognitive radio technologies were expected to improve their communications. Requested by local governments, NICT has setup tens of CWRs for their Internet communications as a mid-term temporally social infrastructure. Although their recovery process is still undergoing, it is proved that the cognitive radio system is of great help for such important operations even in this type of serious disasters.



Figure 7. Install box of the CWR (left) and its inside (right)



Figure 8. NRM and related management servers in Yokosuka

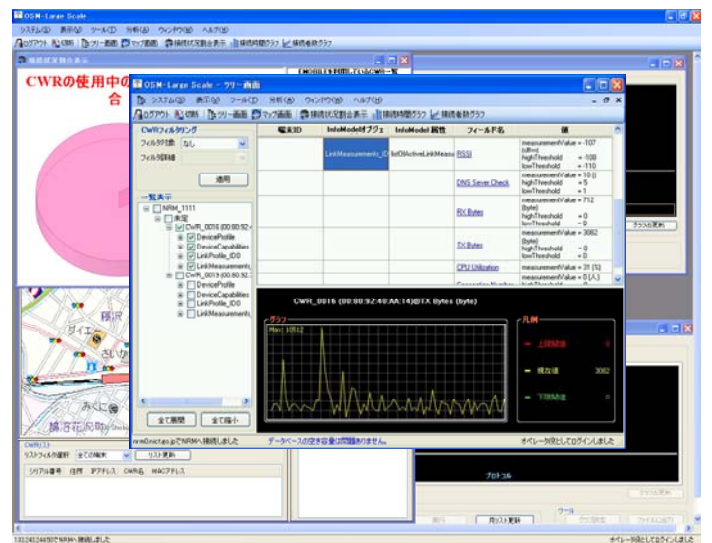

Figure 9. Screen shot of the management software of the test-bed

VI. CONCLUSION

This paper explained necessity of cognitive radio systems (CRS) and introduced two approaches for their realization; heterogeneous type and spectrum sharing type. Both types of the CRSs have been developed for verification and evaluation and large part of their design has been adopted as IEEE 1900.4 and IEEE P1900.4a. Verification study of the heterogeneous type CRS on city-size test-bed is currently operated in

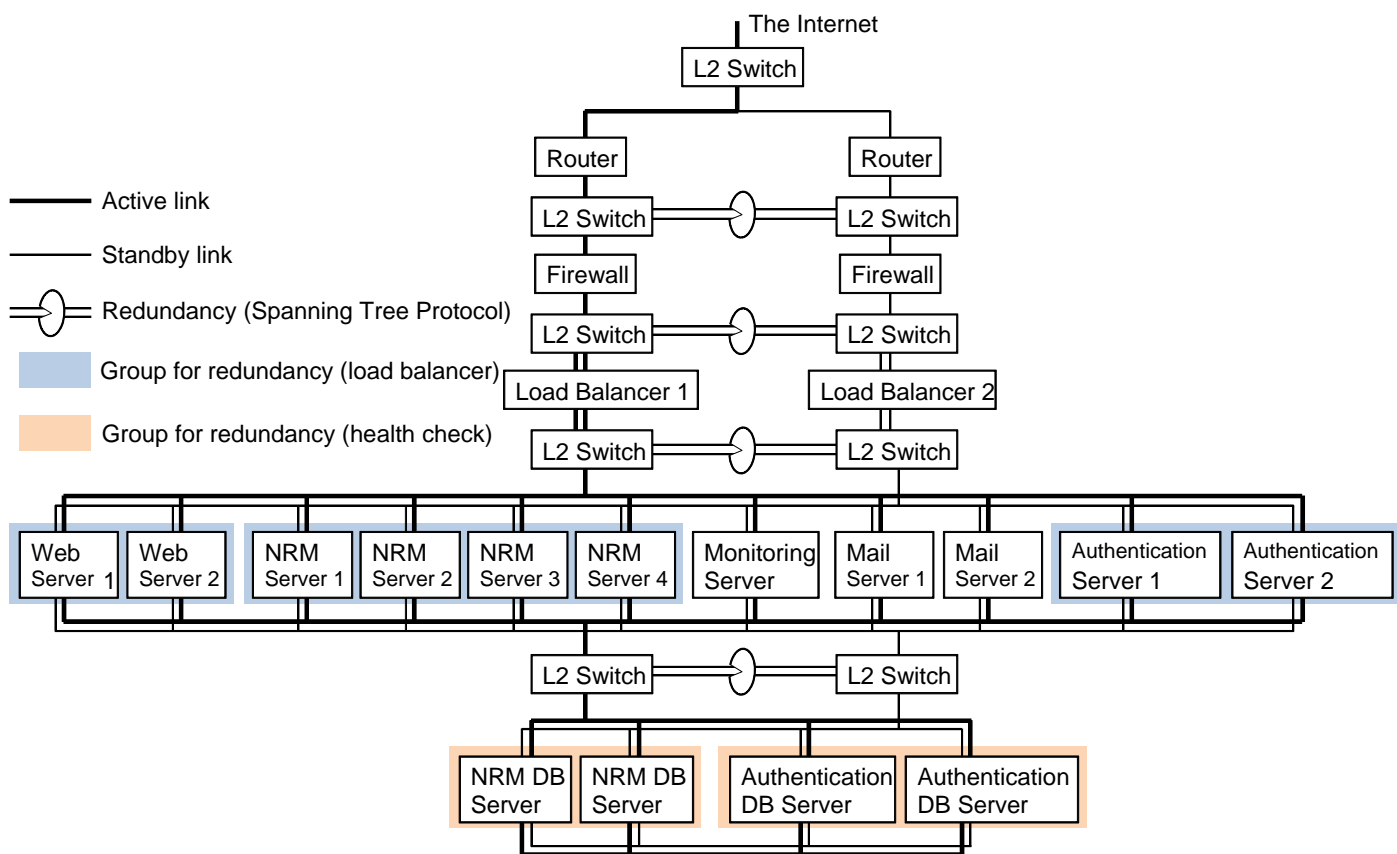

Figure 10. Architecture of the management network

Fujisawa city, Japan. Tens of CWRs are deployed in seriously damaged area to support shelters, hospitals, disaster countermeasures headquarters, in which wired internet connections are not available for their operations.

ACKNOWLEDGMENT

This research was partly conducted under a contract of R&D for radio resource enhancement, organized by the Ministry of Internal Affairs and Communications, Japan.

REFERENCES

- [1] H. Harada, H. Murakami, K. Ishizu, S. Filin, G. Miyamoto, H. N. Tran, Y. D. Alemseged, and C. Sun, "Research and Development on Heterogeneous Type and Spectrum Sharing Type Cognitive Radio System," CrownCom 2009, Jun. 2009.
- [2] K. Ishizu, H. Murakami, H. Harada, "Cognitive Wireless Router system by distributed management of heterogeneous wireless networks," IEICE Transactions on Communications, Vol. E93-B, No. 12, pp. 3311-3322, Dec. 2010.
- [3] K. Ishizu, H. Murakami, G. Miyamoto, S. Filin, H. N. Tran, C. Sun, Y. D. Alemseged, H. Harada, "Mobile Wireless Router System for Seamless Deployment of Cognitive Wireless Technology," WPMC 2009, Sep. 2009.
- [4] K. Ishizu, H. Murakami, G. Miyamoto, S. Filin, H. N. Tran, C. Sun, Y. D. Alemseged, and H. Harada, "Cognitive wireless router capable of link aggregation to realize heterogeneous type cognitive radio," Technical Report of IEICE, Vol. 109, No. 442, pp. 167-174, Mar. 2010.
- [5] K. Ishizu, H. Murakami, G. Miyamoto, S. Filin, and H. Harada, "Design of spectrum sharing type cognitive radio system with out-band pilot channel," Technical Report of IEICE, Vol. 109, No. 442, pp. 37-44, Mar. 2010.
- [6] K. Ishizu, H. Murakami, D. Nishino, K. Shimoiizaka, K. Suzuki, H. Harada, and K. Ogawa, "Functional verification and performance measurements of spectrum sharing type cognitive radio system," Technical Report of IEICE, Vol. 109, No. 442, pp. 45-52, Mar. 2010.
- [7] "IEEE Standard for Architectural Building Blocks Enabling Network-Device Distributed Decision Making for Optimized Radio Resource Usage in Heterogeneous Wireless Access Networks," IEEE 1900.4-2009, Feb. 2009.
- [8] K. Ishizu, H. Murakami, G. Miyamoto, H. N. Tran, S. Filin, M. Hasegawa, Y. Murata, H. Harada, S. Kato, "Design and Implementation of Cognitive Wireless Network based on IEEE P1900.4," Third IEEE Workshop on Networking Technologies for Software Defined Radio Networks, Jun. 2008.
- [9] S. Filin, H. Harada, H. Murakami, and K. Ishizu, "Technical overview of the IEEE 1900.4 standard - Architectural building blocks enabling distributed decision making for optimized radio resource usage in heterogeneous wireless access networks," CrownCom 2009, Jun. 2009.
- [10] K. Ishizu, H. Murakami, and H. Harada, "Development of wide-area cognitive radio testbed for empirical evaluation of optimized radio selection control on municipal scale," Technical Report of IEICE, Vol. 110, No. 153, pp. 81-87, Jul. 2010.