

Development of a TV White Space Cognitive Radio Prototype and its Spectrum Sensing Performance

M. Azizur Rahman Chunyi Song Hiroshi Harada
National Institute of Information and Communications Technology (NICT),
Hikari-no-oka 3-4, Yokosuka Research Park, Kanagawa 239-0847
Email: {aziz, songe, harada}@nict.go.jp

Abstract—In this paper, we describe a recently developed television white space (TVWS) hardware prototype. The prototype includes the following components: a cognitive management entity (CME), a sensing module, a geolocation device, a TV band database, a transmitter and a receiver. The prototype is developed in compliance with recent Singapore TVWS test trial regulations. The prototype operates within 630 MHz to 742 MHz bands, within Singapore TV channels 41 to 54, except channels 50 and 52. The prototype is able to search for existing TV signals in the aforementioned channels by looking at a TV band database, as well as, a by performing sensing. Once the TV channel(s) is/are found vacant, the prototype can intelligently decide to use a single or 2/4/8 continuous TV channels of 8 MHz each. It has the capability to transmit BPSK and OFDM signals and decode the transmitted signals in the receiver. While in operation, if TV signal appears in a single or multiple channel(s), the prototype can switch to vacant channel(s), if available. Otherwise, it ceases operation. The sensing module has capability to sense analog (PAL) and digital (DVB-T) TV signals. Some sensing performance of analog TV signal detection is also presented.

I. INTRODUCTION

Availability of frequency spectrum is one of the key requirements for wireless and mobile telecommunications. However, in any country of the world, the frequency spectrum is a limited resource. Usage of the frequency spectrum is regulated by regulatory institutions such as Federal Communications Commission (FCC) in the USA, Ministry of Internal Affairs and Communications (MIC), Japan, Infocomm Development Authority (IDA) Singapore, etc.

Although the spectrum is a scarce resource, as a matter of fact, over the world, the licensed spectrum is under-utilized. By actively using the under-utilized portion of the spectrum, this is possible to provide many important telecommunications services. This is a branch of research that has recently received attention from researchers and regulators from various countries. Regarding the under-utilized frequency band, a term commonly used is "frequency white spaces". For example, a significant portion of the frequency band licensed to the television (TV) operators is also under-utilized and can potentially be used for other important purposes while not used by the TV operators. Those portions of frequency band are called television white space (TVWS) bands.

In the near future, there is a high possibility of having legal permission of unlicensed use of a lot of WS spectrum in the TV bands in many countries. However, the permission is to come with accompanying requirements to be fulfilled by

the TVWS devices (TVWSD). The USA has already defined the requirements [1], [2]. Many other countries such as UK, Singapore and India have developed draft requirements [3], [4]. As it seems right now, the requirement worldwide are going to be somewhat identical: 1) Ability to access a database that contains information on primary TV users and/or 2) Ability to sense very low power TV signals 3) Ability to process the information received from 1) and/ or 2) and take intelligent decisions.

To work on relevant topics, the Ubiquitous Mobile Communications Group (UMCG) of the National Institute of Information and Communications (NICT), Japan has formed a project named *Advanced Spectrum-management Technology for Radio Access innovation (ASTRA)*. The objective of the ASTRA project includes 1) developing advanced methods and systems for smart access and management of frequency spectrums, i.e. cognitive radio 2) developing appropriate technologies for operation in newly open frequency band, especially to enable unlicensed wireless and mobile telecommunications applications in the TVWS bands 3) developing techniques for spectrum sensing and database access 4) wireless coexistence etc. As a part of this project, recently we have been developing a TVWS prototype. In this paper, we introduce our developed TVWS prototype, explain its architecture, methods of operation and present some performance results.

II. BACKGROUND

In April 2010, IDA, Singapore announced a call for participant in TVWS test trail to be conducted in Singapore to know the technology better [4]. Some initial requirements were set for the test trail, which includes lab test, anechoic chamber test and field test. 12 Singapore TV channels in UHF have been permitted for the trial (channels 41 to 49, 51, 53, 54 that are 8 MHz each in 630 to 742 MHz). Below a summary of the initial requirements are listed:

- Spectrum sensing: required (Recommended: Channels 2 to 12 and 21 to 62)
- Geolocation database access: optional but recommended
- Sensitivity: -120 dBm/channel 8 MHz for UHF and 7 MHz in VHF
- Transmitted Power: 4, 17 and 20 dBm in adjacent channel (41), second adjacent channel (42) and otherwise (43 to 49, 51, 53, 54) respectively or as defined in database
- Listen before talk, detect and avoid: required

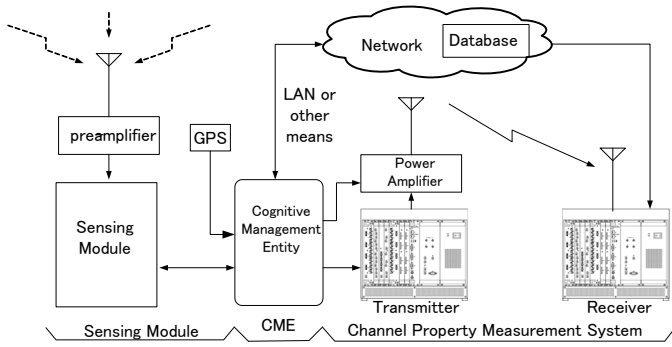

Fig. 1. NICT TVWS prototype block diagram.

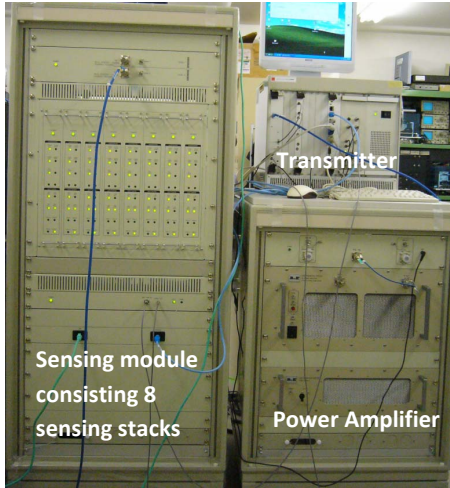

Fig. 2. The NICT TVWS prototype hardware showing the sensing module consisting 8 sensing stacks and transmitter.

- Max continuous transmission 400 ms, min pause 100 ms
- Out of band emission: < -48 dBm/Channel
- Sensing/TVBD info. refresh rate in database: < 1 sec
- Geolocation database refresh rate 24 hours, GPS accuracy < 50 meters
- DVB-T and PAL B and G are primary users

Soon UMCG of NICT decided to take part in the test trial as a part of the ASTRA project.

III. THE PROTOTYPE OVERVIEW

A block diagram showing the component modules connection among them are shown in Fig. 1. The six basic component modules the prototype has are: a cognitive management entity (CME), a sensing module, a geolocation device, a TV band database, a transmitter and a receiver. The CME is a carefully designed software that works as the brain of the whole system and is housed in a laptop computer. The CME coordinates among all the component modules and takes appropriate actions regarding whether or when 1) to perform sensing or access TV band database to become aware of primary users in the channels in use or to be used, 2) to access the geolocation device to become aware of own location, 3) to process all the available information regarding environment and 4) to take

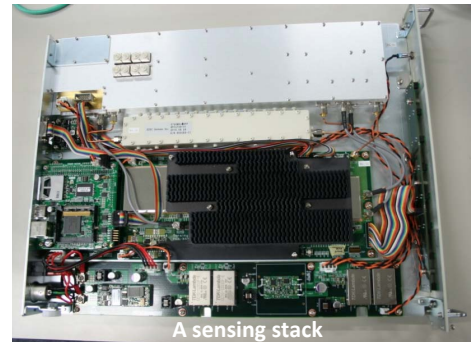

Fig. 3. A single sensing stack of the NICT TVWS prototype.

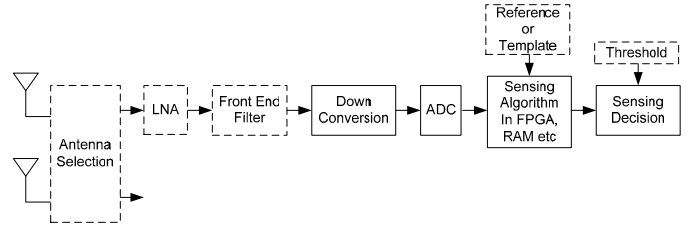

Fig. 4. Block diagram of the sensing module.

intelligent operation regarding own operation. The bottom line is that CME should be able to guide the TVWS prototype to follow the test trial rules at all times.

The sensing module, which is shown in Fig. 2, is composed of eight sensing stacks, sensing antenna connectors, low noise amplifiers (LNA) and local area network (LAN) adapter. Each sensing stack, which is shown in Fig. 3, is capable of sensing a TV channel of 8 MHz. Hence, the prototype is capable of perform spectrum sensing on 8 channels or 64 MHz simultaneously. It has capability to sense DVB-T and PAL TV signals. The TV band database, in its present form, is a passive one and is a Microsoft Excel file that contains primary user information in Singapore TV channels and may also contain secondary user information. The database is currently placed in a local laptop computer and the CME is able to access it to receive and provide (if permitted) information.

The transmitter module is divided in two parts: one is the signal processing part that does all the steps regarding signal generation and the other is the power amplifier (PA) that amplifies and transmits the signal through an antenna. The transmitter has capability to transmit BPSK and OFDM signals. The receiver has only a signal processing part, which can receive and decode the signal transmitted from the transmitter. The receiver has also the capability to process the received signal for channel measurement. The global positioning system (GPS) is used as a geolocation device, which is mounted inside signal processing part of the transmitter module.

IV. DETAILS OF THE PROTOTYPE

Table I shows the major parameters of the developed prototype. As seen, important IDA requirements are being full filled. In 2007 and 2008 several companies developed

TABLE I
MAJOR PARAMETERS OF THE NICT TVWS PROTOTYPE

Operation frequency range	630 MHz to 742 MHz	Sensitivity	-120 dBm/8MHz
Bandwidth	8, 16, 32, 64 MHz	Sensing time	≤ 100 ms
Noise level	≤ -99.6 dBm	Expected sensing performance	probability of false alarm ≤ 0.1, probability of detection ≥ 0.9

TABLE II
EXAMPLE TV BAND DATABASE USED BY THE NICT TVWS PROTOTYPE

Registration ID	Type (primary/secondary)	Standard	GPS (X,Y,Z(meter))	Tx power (dBm)	Technology	Channel(s)	Duration of use
123ABC	Primary	PAL-B	N 1D26M12.14S, E 103D44M09.08S, 30	60	AM/FM	40	continuous
234BCD	Secondary	NA	N 1D26M16.14S, E 103D44M07.08S, 2	13	BPSK	42 to 49	2010/9/1/13:00 to 2010/9/1/17:00

sensing prototypes that were tested by FCC, USA for the requirements of -114 dBm/6MHz sensing level [2]. The sensing requirement imposed by OFCOM and IDA that is -120 dBm/8MHz translates to much lower SNR and is more difficult to reach. First of all, our sensing module of our TVWS prototype has much better capabilities. Secondly, our prototype is a complete prototype that fulfills all the requirements by regulatory bodies for WS operation, i.e. cognitive capabilities, availability and communication capability of GPS, TV band database and spectrum sensors.

Fig. 4 shows a block diagram of the sensing module of the prototype. Although there are 8 parallel sensing stacks, block diagram of a single stack is shown. The blocks shown in dashed lines are optional, however, were implemented in the hardware. The LNA (noise figure (NF) ≈ 2.5) provides 20 dB gain in the front end and defines the NF of the system. The initial intermediate frequency (IF) is 70 MHz and sampling rate is 64 MHz. This translates to 6 MHz secondary IF and 4096 samples per horizontal line of PAL signal of 64 μ s each.

Table II shows an example of a TV band database and its contents as used by our TVWS prototype. Seven essential information were included for each user in the database. The database was an excel file stored in an independent local laptop computer (database server) and was manually managed to populate important information on that. The CME was able to connect to the database server and access the TV band database. The CME was also able to read the information stored, understand and process those to take cognitive action.

V. SENSING PERFORMANCE

A. Review of Existing Sensing Techniques

The simplest and the most well-known sensing technique is the energy detection method (EDM) [5]–[7]. This method can be applied to detect any unknown signal. However, as discussed in [6], the performance of EDM is constrained by the noise uncertainty. Till now, there are a number of improved sensing techniques that have been studied [5]. Among those Eigen value based detection, pilot detection, feature detection, cyclostationary detection etc were discussed in [5]. The most of the above mentioned techniques were developed for sensing

digital television signals. It is found that an effective method for sensing analog TV signal is not commonly available in the literature. Although, our prototype is capable of sensing both DVB-T and PAL signals, in this paper the detection performance of PAL signals will be reported. Note that in many parts of the world analog TV signals still continue to be in use.

B. PAL Signals Basics

In the PAL TV signal [8], moving pictures are produced by flashing 25 pictures per second. Each picture is presented by horizontally scanning it in 625 lines. However, odd and even lines of a picture are shown alternately by making the effective frame rate equal to 50. Each horizontal line is 64 micro second long and is composed of several segments including a Horz Sync pulse that has the highest amplitude normalized to unity or 100%. In the receiver, this helps synchronization and decoding of each line video signal (luminance and chrominance signals) that follows it in most of the lines.

C. The Sensing Technique Used : CBM

A block diagram of the sensing technique developed in hardware is shown in Fig. 5. The technique is called the correlation based method (CBM). In the CBM technique, the signal is received through the RF IN section and then sampled and analog to digital converted by ADC. A time domain reference template is recalled from a buffer where it is stored and a time domain correlation is performed. The correlation output is saved back to the buffer again and many such correlations may be performed. Next the correlation output are averaged and a signal detection is performed based on a predefined detection threshold. For the CBM, we consider a reference signal as shown in Fig. 6.

D. Pre-prototyping Simulation Studies: Setup and Results

Before prototyping we have performed extensive simulation studies of our sensing algorithms. Here simulation setup and results of PAL signal detection will be presented. To save simulation time, we simulated the baseband PAL signal for an 8 MHz channel. The luminance signal was placed at 1.25 MHz above the lower edge of the channel. The chrominance

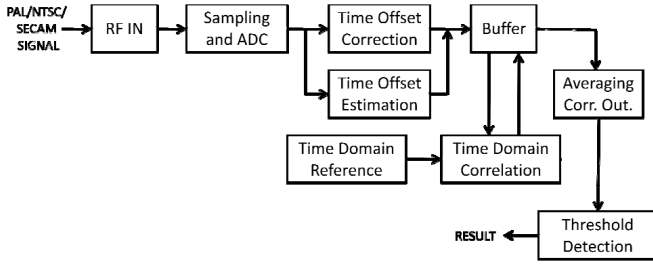

Fig. 5. Block diagram of PAL sensing.

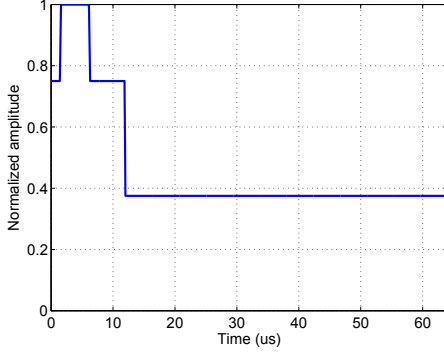

Fig. 6. Baseband equivalent of reference template for PAL Sensing (CBM).

signal and the audio signal were respectively placed above 4.43 MHz and 5.5 MHz above the luminance signal. A sequence of horizontal line contents: horizontal sync pulse, Y (or luminance) signal, chrominance signal, color sub-carrier, audio signal were generated [8].

Probability of false alarm (P_{FA}) and probability of detection (P_D) are two important parameter that determine the quality of a sensor. The P_{FA} depends on noise and interference, whereas, P_D depends on the signal-to-noise ratio (SNR). However, both depend on the sensing algorithm as well. The curves P_D vs. P_{FA} are known as Receiver Operating Characteristics (ROC) and provide quite a detail information about the sensing device. A common requirement by many regulatory environment is that the sensing devices should have a P_{FA} maximum of 0.1 and P_D minimum of 0.9 at some specific power. However, NF must be taken into account.

Both the CBM and EDM methods were simulated in additive white Gaussian noise (AWGN) and Rayleigh fading channels in time and phase asynchronous situation. Figs. 7 and 8 show the ROC curves respectively for asynchronous CBM in AWGN and Rayleigh fading. $SNR = -18$ and -25 and sensing over 1, 2 and 4 lines are considered. The correlation is computed per line and then averaged before making the detection. The threshold (TH) is first set in a way to achieve a specific P_{FA} . Then the P_D is measured for the same TH, implying the same P_{FA} . As it can be seen, it is possible to reach $P_D = 0.9$ at $P_{FA} = 0.1$ for $SNR = -18$ dB just by performing asynchronous CBM over 2 horizontal lines and making decisions after averaging the two correlation outputs. This implies sensing time of 128 microseconds in

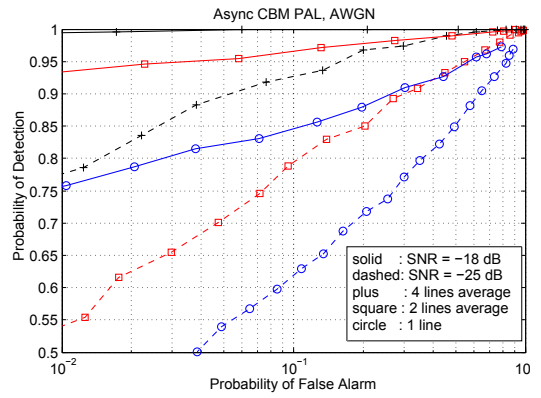

Fig. 7. Simulations: Probability of detection vs. probability of false alarm of PAL Sensing in AWGN channel based on CBM.

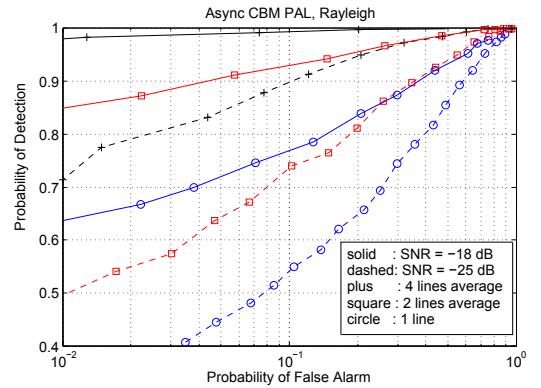

Fig. 8. Simulations: Probability of detection vs. probability of false alarm of PAL Sensing in Rayleigh fading channel based on CBM.

AWGN channel. For $SNR = -25$ dB, similar results may be reached by sensing over 4 lines, implying sensing time of 256 microseconds in AWGN channel. For Rayleigh fading channel, in some cases, it might take more time than AWGN channel. However, reliable sensing results can be achieved.

Fig. 9 and 10 show the ROC curves for EDM in AWGN and Rayleigh fading channels respectively. SNR is used as a parameter and results are shown for $SNR = -15, -20$ and -25 . Results are shown for sensing over 1, 10 and 100 horizontal lines that mean 0.064, 0.64 and 6.4 milliseconds respectively. As it can be seen, although the EDM generally shows worse performance in AWGN, it may be possible to reach $P_D = 0.9, P_{FA} = 0.1$ for $SNR = -15, -20$. However, for $SNR = -25$, it wasn't possible even after averaging over 100 horizontal lines. In addition, if the channel is faded, it may be a catastrophe. As seen from Fig. 10, reaching above $P_D = 0.3$ isn't possible at $P_{FA} = 0.1$ by averaging over any number of lines. This shows the fundamental limit of EDM.

E. Hardware Performance

Once we had enough simulation studies and confidence on our algorithm, we installed our algorithm in the FPGA of the sensing stack. The hardware was then ready for sensing performance evaluation and testing. A major difference

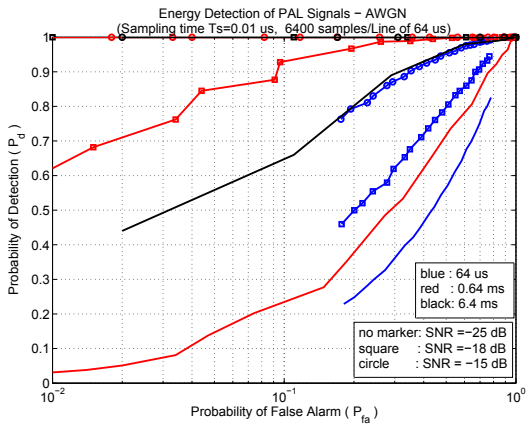

Fig. 9. Simulations: Probability of detection vs. probability of false alarm of PAL Sensing in AWGN channel based on EDM.

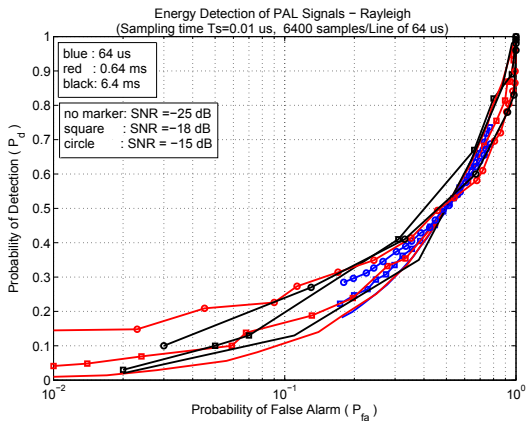

Fig. 10. Simulations: Probability of detection vs. probability of false alarm of PAL Sensing in Rayleigh fading channel based on EDM.

between the simulation setup and the actual implementation is that the simulation was done in baseband, however, we were compelled to develop the sensing hardware operating in intermediate frequency (IF) of 6 MHz. The initial IF was 70 MHz though. The main reason was that tractable and cost-effective implementation of baseband conversion and processing weren't readily available. Another difference was that, the simulation used sampling rate of 100 MHz. However, 64 MHz sampling rate was implemented in hardware considering its suitability.

Only CBM was implemented. However, two variations of the method were used: one using average operation and the other using the maximum selection over a number of correlation operations. Both the differences imply performance degradation in hardware. Especially, the IF based implementation indicated substantial performance degradation as compared to the baseband case. Eventually, in hardware we were unable to reach performance comparable to what we previously obtained in simulations. To solve the problem we considered more numbers of lines or correlation operation to either average or select the maximum.

Table III shows data obtained from the hardware on channel

TABLE III
HARDWARE TESTING, CHANNEL 41: TABLE SHOWING EFFECT OF LINE AVERAGING/MAXIMUM SELECTION ON PROBABILITY OF DETECTION FOR SPECIFIC PROBABILITY OF FALSE ALARM OF PAL SENSING

Lines	TH_{avg}	$P_{FA_{avg}}$	$P_{D_{avg}}$	TH_{max}	$P_{FA_{max}}$	$P_{D_{max}}$
1	7.7	0.093	0.54	7.7	0.093	0.54
2	6.4	0.094	0.70	9	0.096	0.70
8	5	0.095	0.98	11.5	0.092	0.94
16	4.6	0.094	0.999	12.6	0.092	0.987
32	4.32	0.096	1.0	13.5	0.097	0.999

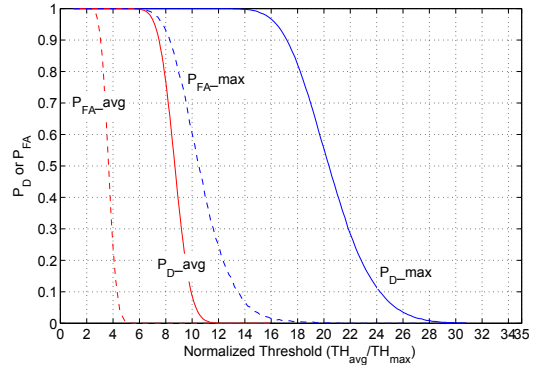

Fig. 11. Hardware Testing, ch. 41: Probability of detection and false alarm vs. normalized threshold for sensing -120 dBm, PAL TV signal.

41 while sensing -120 dBm of a PAL signal. As seen, the P_{FA} was set near 0.1 and P_D was observed for various number of lines for two variations of the CBM. An acceptable performance was obtained for lines number greater than 8. Fig. 11 shows P_{FA} and P_D versus normalized threshold for hardware based sensing of -120 dBm PAL signal while 32 lines were used. As seen by careful selection of the threshold it is possible to detect such level of PAL signal.

VI. CONCLUSION

In this paper, we have presented the features of a TVWS cognitive prototype that was recently developed at NICT, Japan. The overall system architecture, system components and their operation were discussed.

ACKNOWLEDGMENT

This research was conducted under a contract of R&D for radio resource enhancement, organized by the Ministry of Internal Affairs and Communications, Japan.

REFERENCES

- [1] FCC, Second Memorandum Opinion and Order, FCC-10-174A1.
- [2] FCC, "TV White Space Phase II Test Report," available at <http://www.fcc.gov/oet/projects/tvbanddevice/Welcome.html#sec4>.
- [3] Available at wpc.dot.gov.in/DocFiles/IITBproposalTVWhiteSpace.pdf
- [4] Available at <http://www.ida.gov.sg/Policies%20and%20Regulation/20060421164253.aspx>
- [5] IEEE P802.22 draft standard D1.
- [6] R. Tandra, and A. Sahai, "SNR Walls for Signal Detection," IEEE JSAC, vol. 2, no. 1, pp. 4–17, Feb. 2008.
- [7] A. Sonnenschein and P. M. Fishman, "Radiometric detection of spread-spectrum signals in noise of uncertain power," IEEE Trans. Aerospace and Electron. Sys, vol. 28, no. 3, pp. 654–660, Jul. 1992.
- [8] ITU-R, "Conventional television systems," BT.470-5.