

Survey on D2D Resource Scheduling and Power Control Techniques: State-of-art and Challenges

Abi A. Dejen^{1,*}, Yihewew Wondie², Anna Förster³

¹Student at Sustainable Communication Networks Department, Universität Bremen, Germany and School of Electrical and Computer Engineering, Addis Ababa University

²School of Electrical and Computer Engineering, Addis Ababa University, Ethiopia

³Sustainable Communication Networks Department, Universität Bremen, Germany

Abstract

Device to Device (D2D) communication has emerged as the most promising paradigm for optimizing spectral and energy efficiency, reliability as well as increasing network throughput in the emerging cellular generation. D2D resource optimization scheme has been thoroughly investigated in the literature to manage interference and enable its smooth integration into the future cellular network in recent years as an increasing number of papers are published each year. We believe systematic categorization of literature in the area will help readers to comprehend the strengths, weaknesses, and trends of the solution approach. However, a survey that discusses all aspects, requirements, and challenges of D2D resource optimization is largely missing. Hence, in this paper, we aim to develop a comprehensive survey that fills the gaps found in the previous literature. Based on the surveyed papers, it will figure out ideas that have been thoroughly explored and those that assume the potential for further research.

Received on 22 January 2021; accepted on 18 April 2022; published on 04 May 2022

Keywords: Device-to-Device (D2D) communication, vehicular communication, interference management, power control, resource allocation, mobile communication.

Copyright © 2022 Abi A. Dejen *et al.*, licensed to EAI. This is an open access article distributed under the terms of the [Creative Commons Attribution license](#), which permits unlimited use, distribution and reproduction in any medium so long as the original work is properly cited.

doi:10.4108/eai.4-5-2022.173977

1. Introduction

In general, the high level research questions and focus of this paper are stated as follow.

- What are the challenges of the current wireless network and proposed solutions?
- What are the driving factors for the research community to develop network-assisted device-to-device (D2D) communication?
- What are the recent radio resource management and power control paradigms proposed in the literature for integrating D2D communications into emerging cellular networks and how should they be treated?
- What are the potential research gaps that need to be addressed by the research community for its

sustainable integration in the emerging cellular networks?

Wireless communication systems have shown remarkable growth for the past decades. However, the progress to improve the network capacity is far from satisfying the increasing demand for communication service, especially with the emerging bandwidth-hungry device and applications. The current wireless communication system is experiencing exponential growth in the number of subscriber, number of connections per subscriber, mobile data traffic, and users' desire for high-speed connectivity anywhere at any time. In addition to this, new types of hyper-realistic multimedia services are emerging where the current wireless system will struggle to deliver: including vehicle-to-vehicle and vehicle-to-infrastructure communications; industrial automation; wireless health services; virtual and augmented reality services (AR,VR); smart city applications and the use of wireless networks as the primary broadband access

*Corresponding author. Email: abi.abate@aau.edu.et

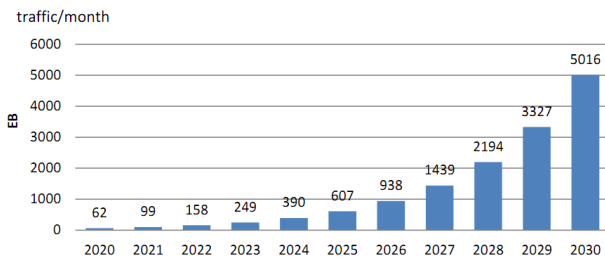

Figure 1. Estimations of global mobile traffic in 2020-2030 [1].

service [2]. And this trend will keep on growing in the future as can be seen in figure 1, which shows mobile traffic growing at an annual rate of around 55% in 2020-2030 [1]. Consequently, the total mobile data traffic generated is predicted to have a 1000-fold increase in the near future [1]. This extremely demand in terms of network resource and link capacity. To satisfy this ever-increasing demand, efficient management of scarce resources is needed than ever. Current networks may offer good service quality in isolated areas, but they cannot meet the extremely growing needs related to new wireless networking uses.

Based on the current trend, the spectrum crisis and users' desire for anywhere, anytime high-speed connectivity that can not be properly accommodated even by 4G, necessitate a new 5G network architecture. The emerging 5G wireless network should maintain tight performance requirements in order to handle higher mobile data volumes, reduced end-to-end latency, massive device connectivity, and consistent quality of experience to provide seamless users experiences. Massive MIMO, device-to-device (D2D), millimeter-wave (mm-wave), and ultra-dense network (UDN) are some of the key enabling technology proposed to maintain the target of the emerging 5G cellular network. Among these techniques, D2D communications enable proximate devices to reuse cellular resources to establish a direct link without passing through the Base Station (BS) [11, 13, 18, 42]. Direct communication among nearby users can substantially enhance the network performance in terms of energy and spectrum efficiency, throughput as well as reduce delay, extend network coverage and offload network traffic as indicated in figure 2.

To address the above challenges and meet the 5G system requirements, it needs a radical change in future cellular network architecture. Considerable research efforts are still required to transform the resulting goals into a coherent and realistic proposition. In a conventional cellular network, all communications must go through the BS and there was an assumption that communicating parties are not in close proximity. This architecture suits the low data rate voice services in which users are not usually in close proximity to have

direct connections. However, in the age of data the main trends are content and interest sharing (e.g., online gaming, proximity-aware social networking) where the communicating parties could potentially be in range for direct communications (i.e., D2D). Hence, proximity awareness has to be taken into consideration in the design of the emerging 5G cellular networks.

On the other hand, the need for massive connectivity with low latency connection requires a fundamental shift from centralized resource management and interference coordination toward distributed and self-organizing approaches, where smart devices can rapidly make resource management decisions. To this end, one of the broad visions of 5G is its emphasis on device-centric solutions and the need for smarter devices. Users are no longer the final resolution of the cellular network but are expected to participate in storage, relaying, content delivery, and computation within the network. D2D communication appears to be an enabling technology for this vision, which allows users in close proximity to reuse cellular resources to communicate directly, bypassing the base station. Hence, D2D communications in such scenarios can highly increase the spectrum efficiency, throughput, cell coverage, and lower latency.

Although D2D communication creates many promising advantages, a number of concerns are involved with its implementation. The most critical problems for integrating D2D communications in cellular networks include dealing with new decision-making criteria for resource scheduling problems, radio resource management, interference coordination, and mode selection. A number of solutions have been proposed in the literature to address these issues and grasp its potential gains. In order to identify the strength and weaknesses of each proposed method and find out ideas which require further research attention, several D2D resource management, and power control strategies have been analyzed and summarized in this paper. What follows in the next section is the key motivation and contribution of this survey paper.

2. Motivation and Contributions

Literature has shown the increasing use of D2D resource optimization scheme for efficient interference management and optimizes different network performance as an increasing number of works are published each year as can be seen from figure 3, which is plotted by collecting the number of paper published each year using *resource allocation and power control for D2D communication* as a search keyword. With such an increasing number of papers in the literature, a survey is the best way to identify the strength and weaknesses of each proposed method and find out which ideas require

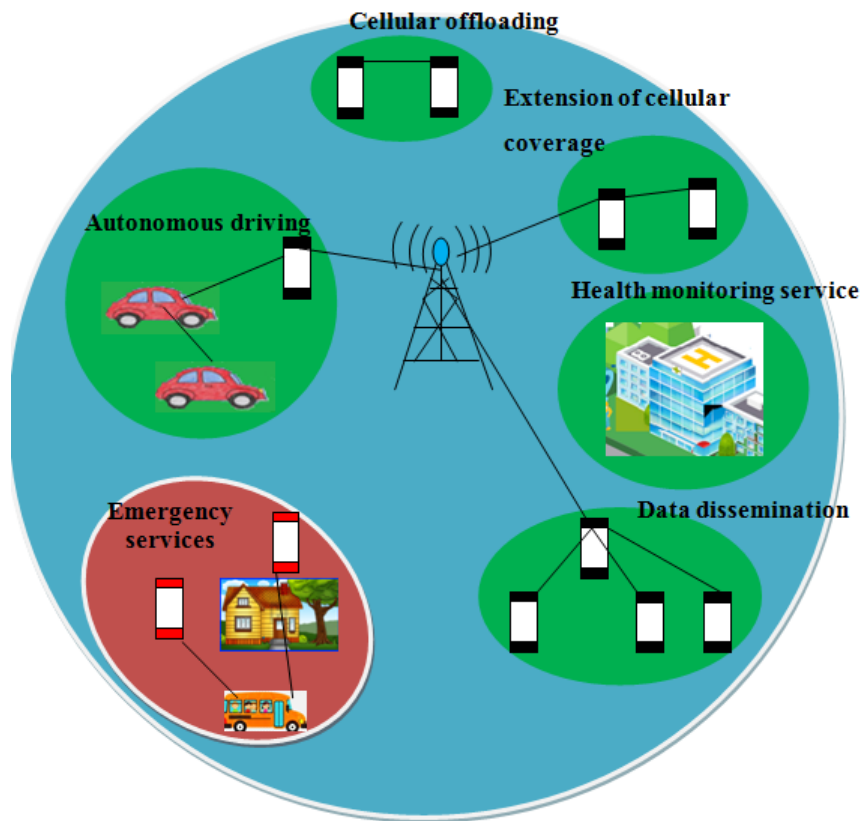

Figure 2. D2D communication: Use case.

further research attention, and put some contribution on the area.

However, a comprehensive survey that discusses all features, requirements, and challenges of D2D resource allocation optimization is largely missing. Currently, there are several survey papers about D2D communication with their different emphasis. In [7, 25], the authors discussed the general state-of-art regarding D2D applications and provide a comprehensive classification of D2D communication. In [8], the authors mainly focus on D2D use cases, protocols, and algorithms for the discovery process, mode selection, as well as architecture in D2D communication and also provide new insight on open issues in these areas. The authors in [23], discussed the concept of D2D communication, implementation challenges, and design issue of D2D enabled cellular networks. Whereas in [24], the authors provide classification based on the D2D spectrum and survey about the existing literature under the proposed taxonomy. The authors in [170] presented an extensive survey on the state-of-the-art techniques proposed for enhancing security and privacy issues in D2D communication and identified an open problem for future direction for its successful implementation. The authors in [171] reviewed the state-of-the-art

methodologies for interference management in D2D underlaid cellular networks. In [172], the authors studied the various resource allocation and mode selection techniques for D2D underlay communications in terms of LTE-Advanced platform.

state-of-the-art methodologies for interference management in D2D underlaid cellular networks

However, any one of these papers doesn't give a comprehensive survey about D2D resource optimization techniques. Exceptionally, the authors in [6] has carried out survey on D2D resource allocation techniques, but it is now old and cannot address the current approach as most of the literatures are published in recent years as can be seen from figure 3. The authors in [115] has also carried out survey on D2D resource allocation techniques, however the comparison is not solid enough to give insights for the readers in the area to figure out the strength and weakness of proposed solution by considering the different D2D communication scenarios. Therefore, it is important to carry-out a comprehensive survey which focuses specifically on D2D resource optimization techniques considering the recent advancement. In contrast to the above survey, our survey focuses mostly on the state of the art techniques regarding an efficient utilization of the scarce and limited resources for successful implementation of D2D

Table 1. List of Acronyms.

Acronym	Full form
3GPP	Third Generation Partnership Project
5G	Fifth Generation
4G	Forth Generation
SE	Spectrum Efficiency
EE	Energy Efficiency
BS	Base Station
D2D	Device-to-device
LTE	Long Term Evolution
MIMO	Multiple Input Multipile Output
ISM	industrial, scientific and medical spectrum
UL	Uplink
DL	Dawnlink
SINR	Signal to Interference plus Noise Ration
IoT	Internet of Things
CSI	Channel State information
ProSe	proximity services
DSP	Digital Signal Processor
P2P	Peer-to-peer
UDN	Ultra Dense Network
QoS	Quality of Service
MEC	Mobile edge Computing
CUE	Cellular User Equipment
ILA	Interference Limited Area
AR	Augmented Reality
VR	Virtual Reality
V2V	Vehicle-to-Vehicle
V2X	Vehicle-to-everything
M2M	Machine-to-Machine
UIP	Uniform Interference Power
MANET	Mobile Ad-hoc Network
CRN	Cognitive Radio Network
MAC	Medium Access Control

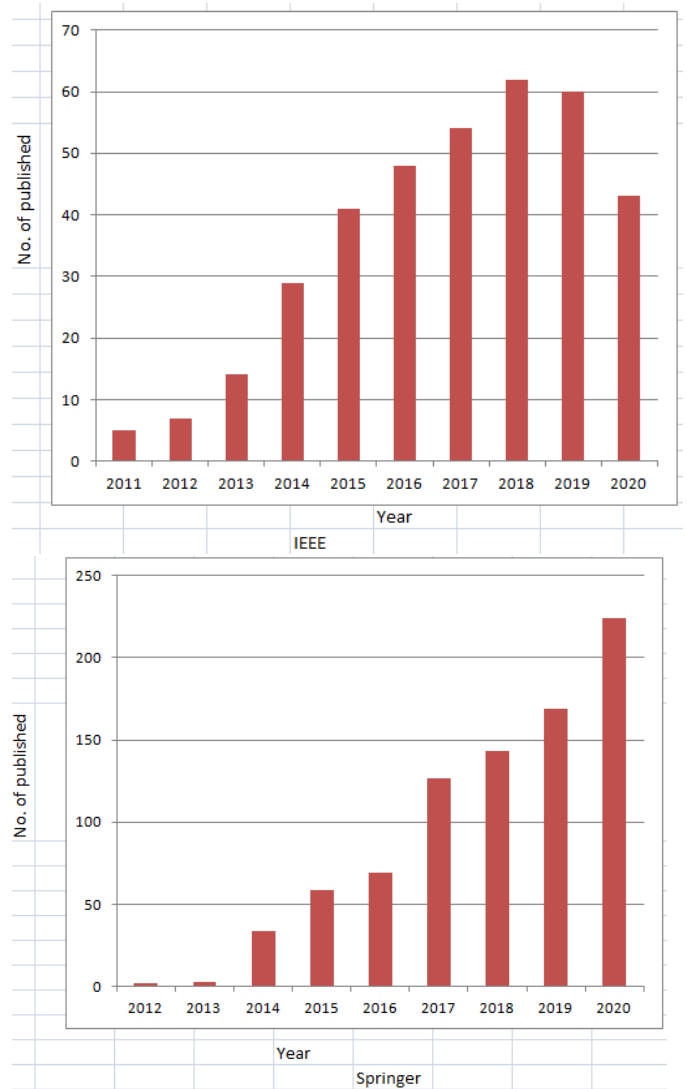

Figure 3. Research trend for resource allocation and power control techniques in D2D.

communication and improved network performance and interference management. Table 2 gives a detail comparison of our survey with existing ones. In general, the main contributions of this survey paper can be summarized as follow:

- Provides an in-depth explanation and classification of the different resource assignment and power control techniques proposed in the literature based on a centralized and distributed approach.
- Classify and presents an in-depth explanation of research on D2D resource assignment and power control techniques proposed in the literature based on inband underlay and overlay approach.

Table 2. Comparison of our survey with existing ones

Reference	Year	D2D Resource optimization						Description	Comment
		Based on BS involvement	Based on D2D Spectrum	Based on Opt. obj.& Const.	Based on D2D Use Case	Based on Solution Approach	Based on Problem Type & Charact.		
[7]	2015	X	X	X	X	X	X	Describe general state-of-art regarding D2D application and provide classification of D2D communication and outline some open research problem.	These papers lacks survey about resource optimization. To fully achieve the potential gain of D2D communication, having an efficient resource management and power control techniques are critical challenges. Hence, how to allocate spectrum and control transmission power optimally to enhance network performance are the fundamental challenge in D2D communication
[8]	2018	X	X	X	X	X	X	Survey D2D use cases ,architecture, protocol and algorithm for discovery and mode selection, as well as new insight on open issues in the area	
[23]	2014	X	X	X	X	X	X	Survey on D2D-assisted cooperative communications and challenges such as relay selection, power consumption and multi casting.	
[24]	2014	X	X	X	X	X	X	Describe general state-of-art based on the D2D communication spectrum and review literature extensively under the proposed taxonomy	
[25]	2015	X	X	X	X	X	X	Provide general classification of D2D related works and address some of the major problem related to D2D communication	
[171]	2021	X	X	X	X	X	X	Provide state-of-the-art methodologies related interference management in D2D communication	
[172]	2020	X	X	X	X	X	X	Describe state-of-the-art related resource allocation and mode selection in D2D communication	
[6, 115]	2017 2020	X	X	✓	X	✓	✓	Describe general state-of-art regarding D2D resource optimization algorithms considering the different problems and solution approaches	However, the comparison is not solid enough to give insights for the readers in the area to figure out the strength and weakness of proposed solution considering the different D2D scenarios
[Ours]	2021	✓	✓	✓	✓	✓	✓	>Describe and give an in-depth explanation and broad classification about the state-of-art regarding resource optimization problems for various D2D communication scenario by considering their different methodology, problems and solution followed in the literatures to tackle the different optimization problems, as can be represented in figure 5 >It figure out the limitations of proposed techniques in the state-of-art and propose potential research directions to be considered by the research community to attain its potential gain and smooth its successful implementation in the emerging cellular architecture >As a limitation, our paper doesn't survey on D2D standardization activity, D2D discovery and mode selection as it is beyond the scope of the work.	

(X :Not considered, ✓ : Considered)

- Gives a detailed analysis of research dealing with channel assignment and power control optimization techniques proposed in the literature considering the various D2D use cases such as resource optimization for D2D based Vehicular Communication, D2D based data dissemination, D2D for emergency service and M2M communication considering their solution approach to tackle the problem, objective, and system characteristic.
- Provides a comprehensive classification of the different resource assignment and power control optimization techniques proposed in the literature based on interference types, methodology, and solution approach to tackle problems, objective, and system characteristics and then provides an in-depth explanation of the related works for each scheme.
- Provides a comprehensive comparison between the different D2D resource optimization techniques. This comparison can help us to get the strength and weaknesses of existing resource optimization techniques.
- Finally, it elaborates on limitations of proposed techniques in the area and potential research direction to integrate D2D in emerging cellular networks.

The next section introduces the methodology followed to address the research question and achieve the motivation and contribution of this survey paper.

3. Methodology

The goal of this survey is mainly to provide an in-depth analysis on state-of-the-art related to D2D resource scheduling and power allocation to understand and analyze the existing solutions and proposals and identify the weaknesses and strengths of each one of them. In order to answer the questions raised in the previous section and achieve the objectives of our research, it is necessary to take a deep look on the state of the art related to the raised issues including:

- Reviewing on state-of-the-art techniques in order to acquire an understanding and knowledge on proposed research question including reading books, articles, and different web-page using *resource allocation and power control for D2D communication* as a search keyword.
- Identifying the pros and cons of existing survey paper in the area.
- Classifying and analyzing existing literature in the area based on their methodology, extent of network involvement and solution approach, objective and constraint, problem type and system characteristics, D2D spectrum and use case.
- Identifying potential research area which is believed to have pro-founding impact on practical operational efficiency of future cellular-assisted D2D systems.

Our survey starts with describing the research questions; the 5G driving factor, 5G challenges and proposed solutions. It then identify the contribution of the work for the research community in the area.

In the second place our survey start with D2D communication; after providing a description of the basic concepts and mechanisms of D2D discovery and communications, we have discussed the D2D use cases and scenarios, and types of interference encountered in D2D communications in order to provide analysis on challenges of the deployment of D2D-based cellular network in future 5G networks.

We introduce in a third place a comprehensive survey on the state of the art of D2D resource optimization and power control techniques. We in this part provided detailed classification and analysis of existing literation in the area based on their methodology, the extent of network involvement and solution approach, objective and constraint, problem type and system characteristics, D2D spectrum, and use case as well as identifying their pros and cons.

In the fourth place, we have presented a broad classification of the different resource assignment and power control techniques based on their interference tolerance, the distance between D2D and direct users, constrained-based optimization schemes.

Next, we have presented recommendations for potential research direction considering the impact of intra-cell and inter-cell interference, user mobility, availability of channel state information, multi-objective optimization, multi-layer heterogeneous networks, multi-antenna base station on implementation of D2D communication in cellular networks.

This state of the art on D2D communications, resource scheduling, and power control schemes can potentially help us to identify the strength and weaknesses of each proposed method and figure out ideas that have been thoroughly explored and those that assume the potential for further research.

4. D2D Communication

In conventional cellular communication, the cellular user first transmits its data to the BS using uplink resources; then the BS direct the data to the corresponding receiver using downlink resources. However, if both communication parties are in close proximity to each other, the BS can allow them to directly communicate with each other. This direct communication mode is referred to as the D2D mode.

Network-assisted D2D communications, which enables direct communication between proximate mobile users, can provide four types of performance merit.

- *Proximity gain*: the short-range direct communication using a D2D link can allow for extremely high throughput, low latency, and power consumption.
- *Hop gain*: this is the gain from not having to use both uplink (UL) and downlink (DL) resources, as is the case when communicating via the base station in the cellular mode as can be seen in figure 4.
- *Reuse gain*: in D2D enabled cellular network, the same spectrum is shared between D2D users and cellular users. This can supports spectrum re-usability and thereby improves the spectrum reuse ratio.
- *Paring gain*: a device with D2D capability can have the flexibility to switch between D2D and cellular mode as needed, creating new types of services.

Apart from the above-mentioned advantages, D2D communications could also bring many more benefits, including cellular coverage improvement, enables new value-added peer-to-peer and location-based

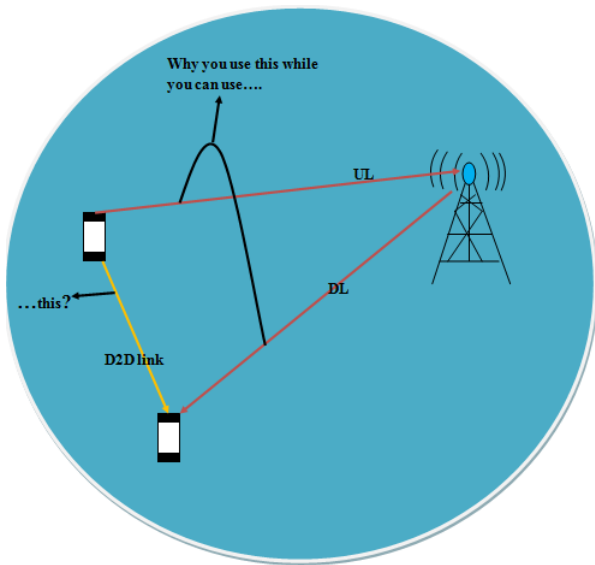

Figure 4. D2D communication in cellular network.

applications and services. Designated for public safety communications, D2D proximity services (ProSe) have emerged as one of the most innovative technologies in 3GPP Release 12. In addition to the high data rates, low latency, and high-reliability requirements, D2D ProSe must further support urgent communications when some or all network infrastructures are paralyzed by natural disasters or malicious attacks.

From an economic perspective, D2D should create new business opportunities. As it has been stated in many literatures, D2D enabled cellular networks can enable operators to provide service with better quality to the subscribers and attract new and retain existing customers. It can also enable the operator to provide a value-added service beyond voice and data services such as local commercial advertisement. In a commercial advertising use case, a local business owner can use D2D to advertise their daily offers to potential customers in nearby. A device capable of D2D functionality placed at business premises and can discover other D2D enabled devices in proximity. Advertising content can then broadcast to the devices that have been discovered. Hence, retailers can use the D2D link to enlarge the relevancy of their promotion with location-specific advertising.

From an architectural perspective, the D2D communication is similar to mobile Ad-hoc networks (MANET) and cognitive radio networks (CRN). However, unlike MANET or CRN, the D2D communications proposed for 5G networks occurs over the licensed cellular spectrum where the network plays a major role in radio resource management, device discovery and synchronization, establishing D2D connections, mobility management, and security. In MANET and CRN, lack of

Table 3. Basic features of D2D communication.

Feature	D2D communication
Spectrum	Licensed (Underlay), Unlicensed (Overlay)
Standardization	LTE Release 12
Communication Distance	Up to 500m
Discovery	Network assisted or device assisted
Quality of Service	Can provides hard QoS guarantees
Maximum data rate	Up to 10Gb/s

coordination and synchronization makes very difficult task to manage interference in order to benefit from resource sharing.

These advantages of D2D communication have motivated academia, the industry as well as standardization bodies to investigate its potentials and work on addressing its technical and business challenge in order to be integrated into the emerging future generation cellular networks. It has been efficiently used in non-cellular technologies, but not investigated for the cellular spectrum for the past mobile generations. It was first introduced in the fourth generation, after LTE release 12, and continuously advanced in the subsequent release. Table 3 summarize the basic features of D2D communication.

The first effort to exploit D2D communication over the licensed cellular spectrum was made by Qualcomm’s FlashLinQ [3]. It was implemented on a digital signal processor/ field-programmable gate array (DSP/FPGA) platform. It enables devices to discover proximate devices up to 1 km range and can be used to provide a new type of service, such as data sharing and advertising. The authors in [4] also designed a system called DataSpotting to investigate the possibility of offloading mobile traffic using D2D communications during peak hours, at train stations, and sport stadiums. Different from “FlashLinQ” and “DataSpotting” which focus on one-hop D2D communication, the authors in [5] developed a D2D system “Relay-by-Smartphone” to realize multi-hop D2D communication for public safety application.

4.1. D2D Communication Mechanisms

The procedure of D2D communication has two phases, discovery, and communication phase. During D2D discovery, D2D enabled user equipment identify the presence of devices in proximity that could potentially communicate directly. This discovery process can be either direct or network-assisted discovery. During the

communication phase, discovered D2D users establish communication links for data exchange. This function consists the procedures that enable the establishment of a communication link between two or more D2D users that are in a direct communication range.

D2D Discovery. The D2D discovery phase can be either direct discovery or network assisted discovery.

- *Direct Discovery:* The direct discovery approach enables the devices to find each other without the help of the BS. The devices transmit the control signal periodically to locate other devices in its surrounding.
- *Network Assisted Discovery:* In network assisted D2D discovery, devices detect and identify each other with the help of the BS. The device informs the BS regarding its communication with devices in its surrounding. The BS initiates the message exchange between two devices to obtain essential information such as channel state, interference and power control based on the network requirements.

D2D data communication. After D2D discovery phase, discovered D2D pairs establish a communication link for data exchange. This could offload the BS through direct on hope D2D communication.

4.2. D2D Communication Scenarios

3G Partnership Project (3GPP) categorizes D2D scenarios in terms of the presence of network coverage as indicated in figure 5.

- *In coverage:* when both D2D users are within the coverage of the cellular network.
- *Partial coverage:* one D2D user equipment is in the coverage of the cellular network whereas the other is out of coverage (it could be a coverage hole due to fading).
- *Out of coverage:* when both D2D users are outside the cellular network. This scenario is considered mainly in 3GPP for public safety use cases when the network is temporarily disabled by natural disasters or malicious attacks.

4.3. D2D Communication Use Cases

The potential application of D2D services have gained significant research attention as they present multiple attractive use cases of new value added services. We mention below some of the more powerful use cases where D2D communication is an effective technique.

- *Traffic offloading:* Data offloading from the core network is one of the most interesting use case of

D2D communication. A device having good link connectivity to the BS can act as a hotspot. The BS can offload/cache data at the hotspot during peak hours and other devices can download data from this device using D2D links. This helps in avoiding congestion in the core network, by enabling traffic to pass through D2D links.

- *Coverage extension:* In D2D enabled cellular networks, a device can get access to cellular network with assistance of one or more devices that act as relays. Cellular users at the cell edge or out of cell coverage or in a disaster-hit area generally encounter poor signal strength while communicating to the BS. The cellular device can relay its transmission to the BS by establishing a D2D link with a device having a better link quality to the BS. This can significantly extend the network coverage of cellular service and enable multi-hop communication.
- *Data dissemination:* Cellular users can leverage D2D links to unicast or groupcast or broadcast files, audios and videos with better data rates and lower power consumption. Besides improving the efficiency of data transmission, D2D communication can also generate new business opportunity for the operators. For instance, shopping malls can use D2D link to broadcast special offers to the people in proximity and improves the relevancy of their promotion with location-specific advertising.
- *Emergency services:* D2D communications can not only improve the network performance but also enable public safety services when the cellular infrastructure is paralyzed due to natural disaster (such as flood, hurricane, and earthquake). Devices in proximity can establish direct connection with each other using cellular spectrum and communicate in the absence of central BS.

Despite these numerous benefits offered by D2D communication, there are still many open challenges to be addressed for its successful implementation. In particular, interference management is the most critical problem regarding with the integration of D2D communication in a cellular network. The reason is that the harmful mutual interference caused by resource reuse can severely degrade the performance of both cellular and D2D communication. Therefore to grasp its promising advantage, issues related to interference should be studied and addressed carefully.

Resource scheduling and power control techniques are investigated to effectively mitigate interference and maintain D2D advantages while guaranteeing service

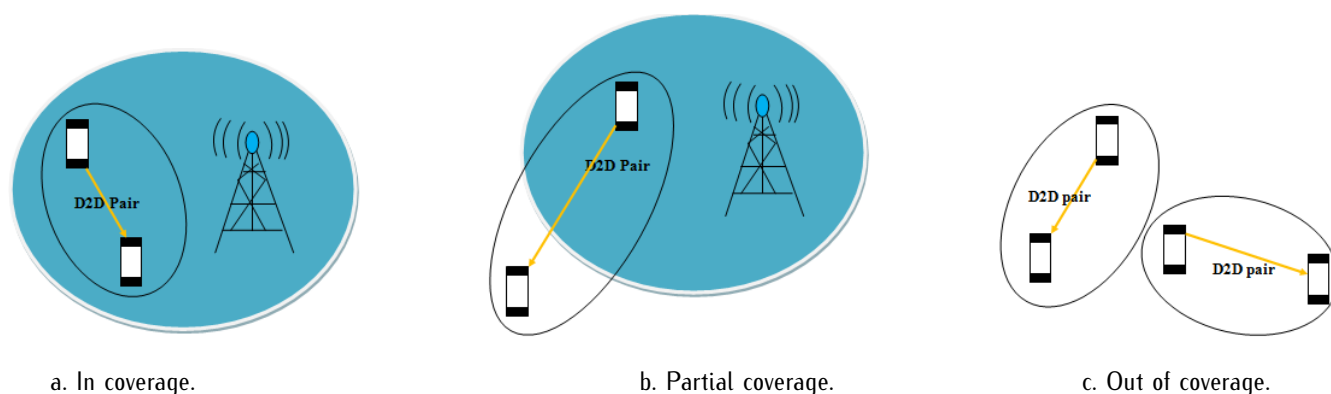

Figure 5. D2D communication scenario.

quality for both cellular and D2D users [12, 15, 26]. Indeed, there has been a recent surge in the literature that proposes new mathematical tools for optimizing resource allocation to manage interference and enable the smooth operation of D2D communications over the licensed cellular spectrum. Optimization theory, game theory, stochastic theory, and graph theory are some of the most commonly studied mathematical tools in the literature to solve the resource allocation problem. A number of D2D resource optimization techniques have been proposed in the literature to achieve the different objectives, such as maximum throughput or data rate, higher energy, and spectrum efficiency while introducing interference constraint to maintain the QoS of the cellular user. A novel categorization of literature in the area can significantly enable the research community to identify the potential limitation of the current approach and work on solving its technical challenges. This survey paper aims to provide the readers the current information about the state-of-the-art literature that has been done on joint optimization of D2D resource scheduling and power control including proposed solutions and algorithms, associated research trends, and figure-out issues that still need to be addressed further.

5. Types of Interference in D2D Communications

In D2D enabled cellular networks both co-tier and cross-tier interference are introduced. Co-tier interference occurs between D2D pairs sharing the same resource while cross-tier interference is produced between co-channel D2D and cellular users. This type of interference occurs when the resource assigned to cellular users are reused by one or more D2D users. The node affected by interference depends on D2D communication modes and the resource used for D2D communication (uplink/downlink).

- **D2D-to-cellular interference:** Interference from the D2D communication to the cellular communication occurs either at the base station or cellular user depending on the direction of communication. In the UL direction, the interference is caused to the base station, which receives data from its cellular users as depicted in figure 6. In the DL direction, the cellular users are the victims of the D2D interference as they are receiving data from the base station at the same time as the D2D users exchange data among themselves.
- **Cellular-to-D2D interference:** Interference from cellular communication to D2D communication can also depend on the direction of communication. In the UL direction, the interference is generated by the cellular user, which transmits to the base station. Whereas in the DL direction the base station will be the interferer as it transmits to cellular users. In addition to this, when more than one D2D pair share the same resource, harmful mutual interference will be generated between D2D pairs. Regardless of the transmission direction, interference always exists between transmitting and receiving D2D users in different pairs using the same resource.

6. Classification and Fundamentals of Resource Optimization in D2D Communications

This section entitled to gives a broad classification and exploration of the various D2D resource optimization techniques followed in the literature to attain its realistic and potential gain and facilitate its smooth integration in mobile-cellular networks. Figure 7 shows the detailed categorization of the various resource optimization scenarios considered in the literature.

6.1. Centralized and Distributed Schemes

The different D2D resource allocation approach proposed in the literature can be broadly categorized in

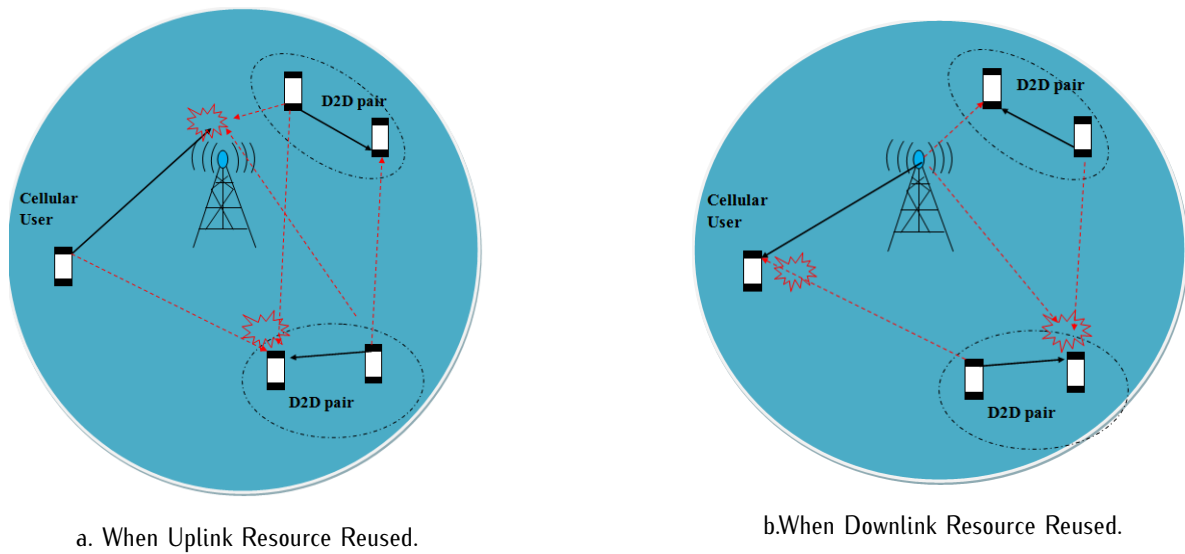

Figure 6. Interference in D2D communication.

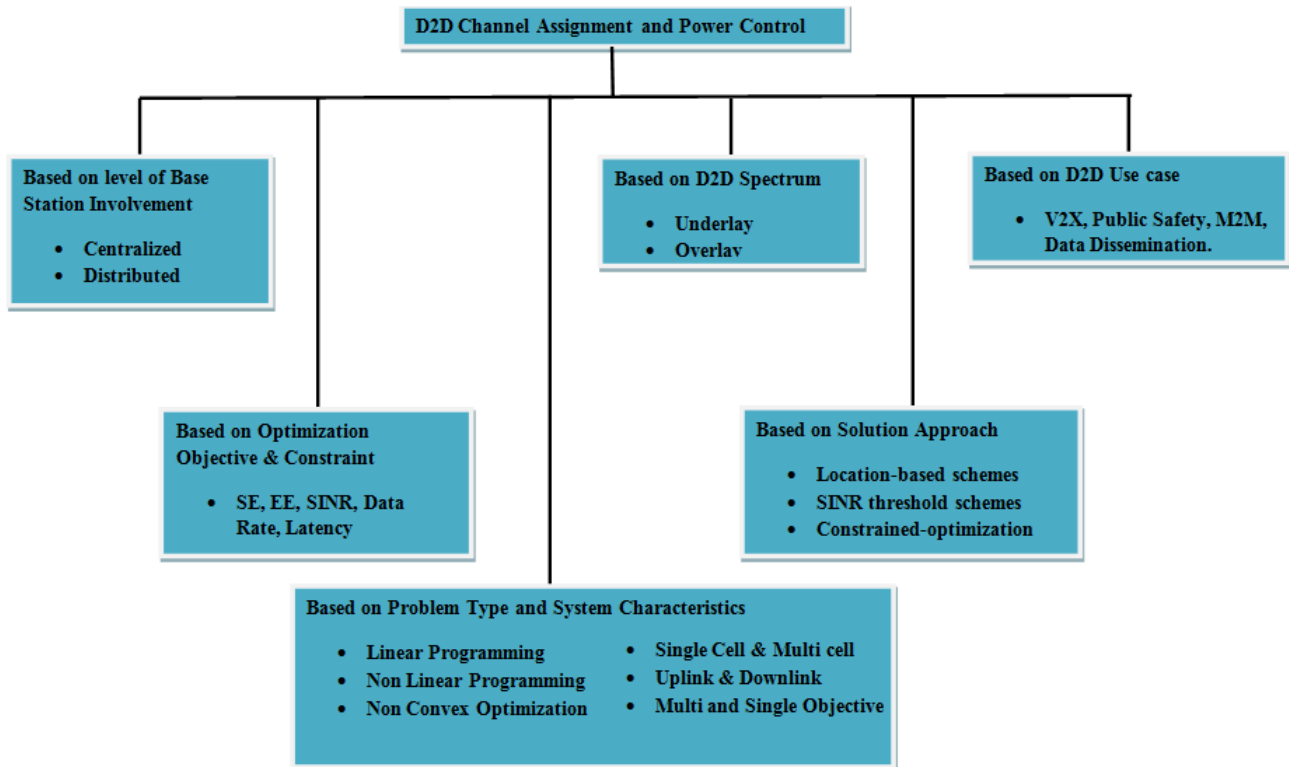

Figure 7. Classification of D2D resource assignment and power control

either distributed or centralized implementation. In the centralized solution, the central controller (network) is fully responsible to manage interference between cellular and D2D user. This centralized approach requires the channel state information (CSI) between every transceiver as well as the minimum tolerable interference level for each channel and based on the information obtained, it allocates the resource to each D2D

pairs. The main drawback with a centralized scheme is the amount of signaling overhead required for exchanging channel state information. The resource optimization complexity can also increase exponentially with the number of D2D pairs, as it is performed by a single entity, which has to process a large volume of data. Hence, centralized resource optimization techniques are only possible for small-sized D2D networks. Table

4 categorizes some of the research conducted on D2D interference management and resource optimization based on the level of base station involvement as a centralized and distributed approach. As centralized resource optimization techniques result in an optimum solution, their implementation was the main focus of literature in the area for the past years. The authors in [9, 10, 17] exploit centralized resource allocation with an objective to maximize spectrum efficiency whereas in [11, 22], the authors formulate a centralized resource optimization algorithm to minimize power consumption. The authors in [50], proposed a resource allocation scheme which is based on the soft frequency reuse (SFR), using power control to mitigate interference considering both licensed and unlicensed band for D2D communications. The simulation result shows that the proposed scheme achieves better performance in terms of system capacity and blocking rate compared with the conventional allocation scheme that is purely uses the licensed band and does not support D2D.

The authors in [65], investigated joint resource allocation and power control problems for cooperative D2D users which multiplex cellular users in downlink cooperative D2D heterogeneous network. The formulated resource allocation optimization problem contains resource block allocation and selection of an idle user which work as a relay to help D2D communication, while the power control aims to reduce the interference between the user and enhance communication quality of service. To efficiently maximize the total throughput of all the D2D and the cellular users while guaranteeing the quality of service for the primary cellular user, they propose a quantum coral reefs optimization algorithm (QCROA) to obtain the optimal joint resource allocation and power control scheme. Their result shows that the proposed algorithm achieves an excellent performance for different communication scenarios.

In order to mitigate the D2D-to-cellular interference and improve the spectral efficiency, the work in [75] proposed an efficient channel selection and power allocation scheme while guaranteeing the service quality of both cellular and D2D user, where multiple cellular channels can be reused by each D2D pair. By using the Lagrangian method, the optimal power of the D2D user is determined to maximize the D2D sum rate while preserving the QoS of the cellular user, thereby not affecting the normal cellular communication. The authors also discussed the throughput performances of D2D users which can be affected by the position and separation distance between D2D and cellular users.

The authors in [103], proposed a uniform interference power (UIP) resource allocation scheme in order to reuse the uplink cellular resource for D2D communication and analyzed spectral efficiency. Using the base station to control the transmission power of all user terminals, their proposed scheme ensures that each

D2D user reusing cellular resources contributes the same interference power at the BS without negatively impacting the cellular user. Their result shows zero outage probability for the cellular user while the cell spectral efficiency is enhanced.

However, with the densification, massive connectivity, and heterogeneity of future cellular networks centralized scheme is hard to implement due to its huge signaling overhead for collecting CSI information. Effectively managing resource allocation in such a complex environment needs a fundamental shift from centralized solutions toward self-organizing and distributed approaches. In the case of distributed schemes, the involvement of the BS in resource allocation is reduced, as decisions are being made by the devices. Hence, the operation of channel assignment and power control does not require a central controller and is performed separately by each D2D user. Due to limited channel state information and feedback, the distributed scheme can reduce the control and computational overhead. Although distributed methods reduce the computational complexity, it is important to know that as it is based only on local information, interference is difficult to coordinate and result in sub-optimum performance; this technique is more preferable for large size D2D networks.

The authors in [41] proposed a novel scheme in order to optimize the effectiveness of D2D enabled vehicular communications (D2D-V) underlaid in a cellular network, where the uplink cellular channel is reused by multiple D2D-V links. They formulated cellular user interference constraints to address the mobile channel fluctuations as a probabilistic function by the Bernstein approximation. A distributed power control algorithm is proposed to perform the chance-constrained optimization. The work in [62] proposed a two-phase decentralized resource allocation scheme for Device-to-Device underlying cellular networks. During the first phase, the D2D pair learn the resource block (RB) of the cellular user to be used, while playing an interference minimization game. Each D2D pair is guaranteed an interference below an upper limit, which is selected as a criterion for admission control. In the next phase, power allocation for the D2D pair is carried out to maximize their sum rate while maintaining a minimum rate for the cellular user using a pricing scheme.

6.2. Inband and Outband approach

From a resource allocation perspective, D2D communication can occur either on the cellular spectrum (Inband approach) or on the unlicensed spectrum (Outband approach), as depicted in figure 8:

- Outband D2D: In the case of outband D2D communication, the D2D link exploits the unlicensed

Table 4. Centralized and Decentralized Resource Allocation in D2D communication

Reference	Optimization problems	Description
[9, 10, 17]	Centralized, non linear Programming and Convex optimization	Proposed joint optimization of channel and power allocation to: .Genetic Algorithm used maximize the spectral efficiency .Self adaptive power control strategy to maximize energy efficiency
[11, 22]	Centralized, Non-convex and stochastic optimization	.Stackelberg game based resource optimization framework to reduce power and increase throughput . Lyapunov and weighted sum method are used to maximize EE and SE
[12, 13, 15, 16, 18, 19]	Distributed and non linear Programming	In uplink D2D , joint channel and power allocation is considered: .Iterative combinatorial auction is used ensure QoS and increase EE . Coalition Game and whale optimization algorithm to optimize power allocation and system throughput .Stackelberg game with pricing is used to allocate channel and power to D2D pairs while ensuring QoS .Iterative matching-stackelberg game exploited to maximize D2D throughput
[31]	Non linear Programming	Joint power control and resource scheduling scheme for underlay D2D networks to enhance: .Maximize network throughput and users' fairness
[32]	Non linear convex optimization	QoS aware Channel assignment and Power control for uplink D2D Communication is proposed: .Maximize D2D sum rate .Minimize D2D-to-cellular interference .Applied convex optimization for D2D pairs to control interference
[45]	Centralized non linear optimization	Bee Life Algorithm is proposed resource allocation and power control for D2D Communication .To optimize channel and power allocation .To find optimal solution via a diversified global search among all possible solutions .To escape a stagnation on local optimal by applying a biological process inspired by the bees' marriage behavior
[50]	Centralized MINP	Soft frequency reuse based resource allocation algorithm is developed to: .Adopt power control and alleviates interference .Use both licensed and unlicensed band for D2D
[65]	Centralized non linear optimization	Proposed quantum coral reefs algorithm .For joint resource and power allocation. .Reduce interference b/n users and improve communication quality .Maximize the total throughput .Guaranteeing the QoS of cellular users
[75]	Non convex non linear Programming	QoS aware channel and power allocation scheme for D2D underlaid network is developed .To mitigate interferences from D2D .Maintain primary cellular user QoS. .Lagrangian method exploited to get optimal power of D2D
[103]	Analytical optimization	Proposed a uniform interference power (UIP) resource allocation for uplink D2D network .Result show zero outage probability for cellular user .SE is enhanced by 20 times compared with no resource reused
[41]	Distributed and Non convex optimization	formulate cellular user interference constraint as a probabilistic function by Bernstein approximation .To address the mobile channel fluctuations .To studied effectiveness of D2D enabled vehicular communication .Uplink channel reused by the multiple D2D
[62]	Distributed Stochastic Learning Algorithm	Distributed resource assignment algorithm developed to: .Maximize D2D sum rate .Minimize D2D-to-cellular interference .To have stable admission control and power allocation

spectrum (ISM). In outband D2D communications, there is no interference between cellular and D2D users. However, due to the uncontrolled nature of ISM band, it can suffer severe interference among D2D pairs.

- Inband D2D: In the case of inband D2D, the D2D pair reuse the licensed cellular spectrum to establish a direct communication link. The main

advantage inband D2D communication is usually the high control over the cellular spectrum. In inband D2D communication, D2D users can access the cellular spectrum either in underlay and overlay mode. In underlay D2D communications, cellular and D2D communication share the same resource.

In contrast, in overlay D2D mode, the D2D communication occurs over a dedicated cellular spectrum and the cellular user cannot use the full

Table 5. Underlay and Overlay D2D Resource Allocation

Reference	Comm.scenario	Optimization problems	Description
[9-114]	In band Underlay	Centralized and distributed resource optimization	Stochastic Learning, machine learning, Matching game, QCROA, Bio-inspired approach, heuristic, graph theory and more algorithm has been exploited .It is the focus of the research community
[116]	In band overlay	Maximum weighted matching	Heuristic dedicated sub-granting radio resource algorithm scheme for underlay D2D networks to enhance: .Maximize network throughput and users' fairness
[118]	In band overlay	non-convex optimization problem	Spectrum-power trading scheme proposed to maximize the weighted sum EE of D2D users
[120]	In band overlay	nonconvex optimization	Proposed distributed power allocation for D2D overlaying an OFDMA network .To maximize user sum rate subject to power constraint
[122]	In band overlay	stochastic geometry	Carryout analytical modeling of resource allocation in uplink D2D overlaying .Analyzed how different parameter affect coverage probability and ergodic rate of user
[124]	In band overlay	binary linear programming	Minimum rate proportional fairness algorithm exploited .Results show the effectiveness of proposed scheme.

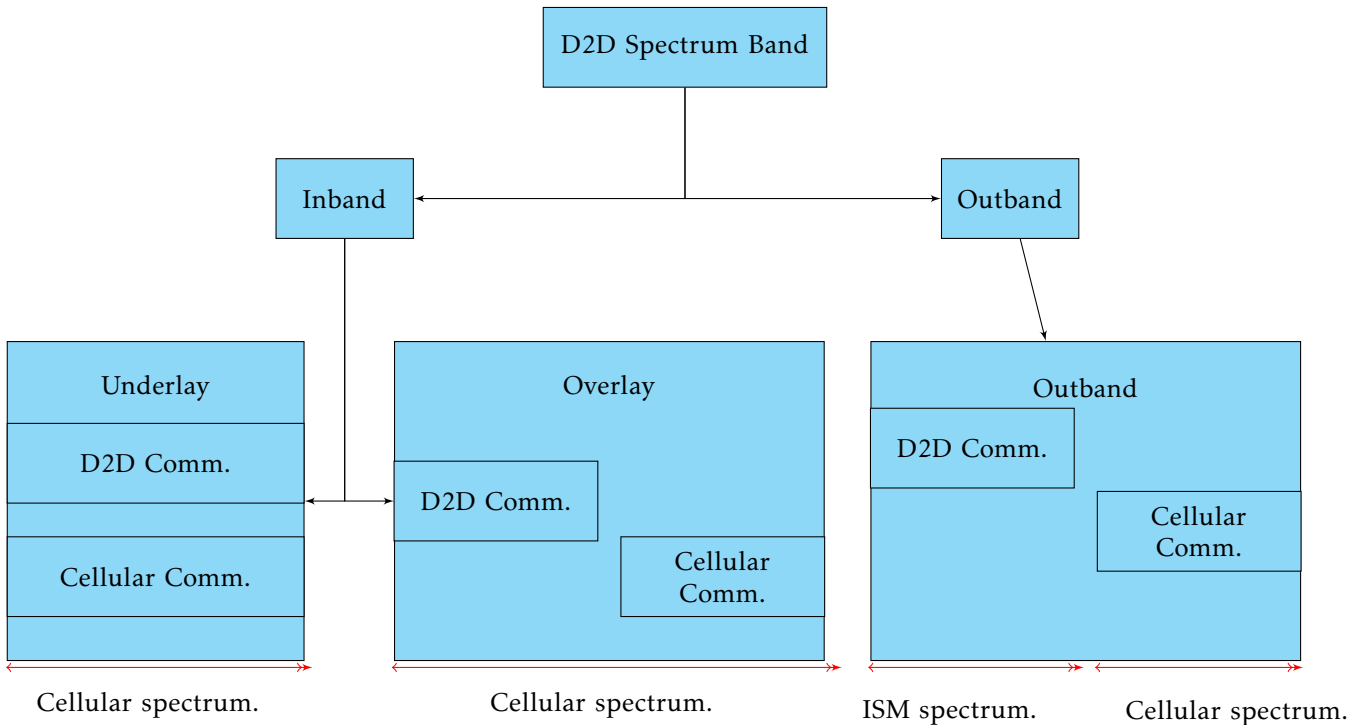

Figure 8. Schematic representation of D2D spectrum.

capacity of the network. Due to the high reuse factor, inband underlay D2D can improve the spectrum efficiency of cellular networks and has got wide research attention from the research community. However, it may also bring in co-channel interference between D2D and cellular links. This interference can be mitigated by introducing efficient resource allocation policies. Table 5 categorize some of the research conducted on

D2D interference management and resource optimization based on inband underlay and overlay D2D communication network. The author in [116] proposed hierarchical radio resource allocation, sub-granting scheme, to optimize radio resource utilization and enhance cell throughput in overlay D2D communications subject to reliability and latency requirements for D2D communication. The authors investigated the sub-granting radio resource assignment problem for the device to

infrastructure (D2I) user. Simulation results show promising improvement for the proposed scheme compared to some other existing approaches.

In [117], the authors developed an efficient D2D couple scheduling strategy in overlay cellular networks to increase spectrum efficiency as well as throughput. The proposed solution maximizes throughput while minimizing packet dropping probability and average packet delay. The performance of the proposed algorithm has been evaluated considering packet dropping probability and average packet delay.

The author in [118] proposed a spectrum-power trading strategy for D2D overlaying communications to maximize the weighted sum energy efficiency of D2D user via joint D2D relay selection, bandwidth allocation, and power allocation while guaranteeing the QoS of the cellular user.

In this survey, we devoted our attention to resource optimization techniques proposed for inband D2D communications where the D2D paradigm is expected to have a significant role in achieving the tight 5G requirements and the network plays a major role in initiating, coordinating, and optimizing D2D communications and can improve the spectral efficiency significantly.

6.3. D2D Resource Optimization for Vehicular Communication

The continuous advancement in vehicular communication technology has led to the introduction of autonomous vehicular technology, which relies on vehicle-to-infrastructure, and vehicle-to-vehicle communication. Autonomous vehicles may need to exchange information such as traffic monitoring, infotainment data, and map data with other vehicles in the network. However, high mobility, bandwidth-hungry, low latency, and high-reliability requirement of the vehicular communications network are still the big challenge that needs to be addressed by the research community. On the other hand, the high reliability and low latency features of D2D communications make it to be one of the key promising technology of the emerging intelligent transportation system. For D2D-based vehicular communication, how to efficiently and quickly allocate resources is a big challenge to address interference resulting from resource sharing. Thus, for D2D-based vehicular communications, it is indispensable to design an efficient spectrum sharing and power allocation algorithm for interference management and resource optimization. Table 6 summarizes some of the research conducted on interference management and

resource optimization for D2D based vehicular communication network.

The work in [132] investigated a joint channel assignment and power control problem to secure cellular underlaying V2V communication with an objective to maximize the secrecy rate of vehicular channels, where cellular and vehicles have the same priority. Numerical values show that the secrecy rate of their proposed scheme can be significantly improved compared to the existing scheme.

The author in [133] investigated a joint power control and resource allocation problem for D2D based V2X communication with an objective to maximize the sum ergodic capacity of the vehicular user under imperfect CSI and minimum SINR requirements of the cellular user. The numerical result shows the effectiveness of the proposed algorithm and elaborated the proposed scheme can improve sum ergodic capacity.

In [141], the authors have proposed and investigated a cluster-based radio resource management scheme for D2D based safety critical vehicle-to-everything communication where resources are shared between different vehicular and cellular users. Their numerical result indicates a promising performance in terms of the key performance requirement latency and reliability.

6.4. D2D Resource Optimization for Efficient Data Dissemination

Due to the high data rate, low delay, and energy consumption, high bandwidth efficiency, and throughput features, D2D communication has got wide research attention from the research community for efficient data distribution and caching strategy. Having efficient data dissemination techniques is indispensable for supporting many D2D based content distribution and location-aware advertisement. Table 7 summarizes some of the research conducted on resource optimization for D2D based data distribution.

The authors in [143] proposed cooperative video content caching and dissemination strategy for the D2D communication network. They have investigated their proposed algorithm in terms of goodput and energy efficiency. In [145], the authors' proposed delay constrained data deposition for profit optimization in a D2D network, where receivers are unknown and data must be delivered to the receivers within an opportunistic delay constraint. The authors have proposed three algorithms, i.e. Direct selection of one and L Depositories, and Mixed Online Selection of L Depositories, and also evaluated their system performance. The author in [150] proposed a coalition game based on efficient data dissemination with power constraint for D2D based data distributions. Their numerical result shows a promising performance as compared to an optimal solution for various scenarios.

Table 6. Resource Optimization for D2D-based Vehicular Communication

Reference	Optimization problems	Description
[130]	optimization problem	Proposed heuristic Graph Coloring Based algorithm to: .Maximize capacity .Guarantee stability of V2V transmission requirement
[131]	convex optimization problem	Developed reinforcement learning based slicing framework and optimization solution to: .Balance resource utilization and QoS satisfaction levels
[132]	mixed-integer non-convex optimization	Proposed joint radio resource and power control to: .Secrecy rate maximization
[133]	nonconvex optimization	Proposed distributed resource allocation based on enhanced Gale-Shapley algorithm for to .Sum ergodic capacity of vehicular user .Maintaining minimum SINR requirements cellular user
[134]	Multi agent power allocation problem	Deep reinforcement learning based power allocation .Network energy efficiency and flexibility
[135]	Non-linear and non-convex objective function	Proposed Coalition game based resource allocation scheme .Maximize minimum throughput V2V link .Minimum V2I link throughput constraint.
[136]	Non-linear optimization problem	Proposed immune algorithm based resource allocation .Maximize system throughput
[138]	Non-linear optimization problem	Proposed location partition based resource allocation for in-band D2D based vehicle-to-vehicle communication .Maximize sum rate
[139]	stochastic optimization problem	Proposed Lyapunov optimization based resource allocation for D2D based vehicle-to-vehicle communication .Maximize sum rate downlink cellular use .Latency and reliability requirement of V2V communication
[140]	Non-linear optimization problem	Proposed joint optimization of resource, power allocation, and modulation scheme, to maintain . Latency and reliability requirements of vehicular use . Maximizing information rate of cellular user
[141]	Non-linear NP-hard optimization problem	Proposed cluster based resource management for D2D based v2x safety critical

Table 7. Resource Optimization for D2D-based Efficient Data Dissemination

Reference	Optimization problems	Description
[142]	Stochastic optimization problem	Proposed caching strategy for mobile social networking in 5G and beyond to: .Maximize performance of mobile social network. .Provide an in depth study of user mobility and QoS factor
[143]	Optimization problem	Proposed distance and priority class based cooperative caching algorithms to .optimize system wide energy consumption improve system service capacity
[144]	optimization problem	Proposed D2D assisted VR video dissemination and pre-caching algorithm based on QoE gain .improve QoE. .Under storage space and energy constraint
[145]	NP-hard optimization problem	Proposed delay constrained profit maximization for data deposition and distribution for D2D network
[146]	Mixed integer nonlinear problem	Proposed interference aware D2D pairing for collaborative data distribution
[147]	Mixed integer nonlinear optimization	Proposed an energy aware efficient data distribution techniques with D2D Communications with weighted social community
[149]	Mixed integer linear optimization	Proposed stable D2D user pairing for collaborative data distribution and effectively pair requesting user with caching user in close proximity.
[150]	Optimization problem	Proposed a coalition game based data dissemination under minimum total power consumption Constraint.

6.5. D2D Resource Optimization for Efficient Emergency Service

Despite the great development in mobile communication technology, there are still significant challenges to maintain stable communication services when the communication infrastructure is fully or partially damaged. With the recent increase in popularity of D2D communication technology, the research communities are focusing their attention on the development of multi-hop data delivery using mobile user devices independent of the operator network, which will allow emergency message delivery from the disconnected area. Table 8 summarizes some of the research conducted on resource optimization for D2D based public safety communication.

The author in [154] proposed caching strategy for D2D-assisted wireless emergency communication in order to maximize the effective capacity subject to delay constraint and conducted a numerical simulation to elaborate the performances of their proposed strategies. The authors in [157] developed SINR based synchronization protocol to help users in a victim area to establish a synchronized communication for public safety applications. Through numerical simulation, the authors have shown that their proposed protocol enabled more than 90% of the D2D device can successfully synchronize with the network, whereas only 75% of D2D users can successfully be connected with the network through the conventional protocols. The work in [161] proposed a cluster-based MAC scheme to support efficient D2D based emergency communication for a public safety service in a natural disaster area where the conventional cellular networks are paralyzed or malfunction.

6.6. D2D Resource Optimization for M2M Communication

In the emerging 5G and beyond 5G wireless communication, a massive number of the device need to access network with diverse quality of service requirement. It is estimated that machine-to-machine (M2M) devices will account nearly half of the total number of devices connected in the emerging network. Application of M2M communication can include smart home and health care, smart cities, environmental monitoring, intelligent transportation system, and even to the industrial domain. These applications of M2M communication requires massive device connection with diverse QoS requirement, and low power consumption. On the other hand, in order to cope with such a massive number of the device with divers requirements, there is a need for new paradigms to coordinate the access and exploit the scarce and limited resource efficiently. Hence, an efficient radio resource management scheme can play a vital role in the successful implementation of

M2M communication. D2D is one of the key enablers of M2M communication. Table 9 provides a comprehensive survey on state-of-the-art research activity on radio resource management scheme in M2M communication.

The work in [162] investigated the medium access control (MAC) protocol for D2D systems with the synchronous transmission in order to provide sharing resources and protect the M2M system with asynchronous transmission using the ISM band. The author developed an analytical model based on the MAC protocol and studied the throughput performance of D2D and M2M sharing unlicensed spectrum. In [163], the authors investigated the problem of how to guarantee the massive and reliable connection requirement of M2M communication and route M2M data in a cost-effective manner. The authors proposed D2D based multi-hop M2M communication and developed a stochastic geometry-based model to investigate the coverage probability and average data rate of M2M communication. Their numerical result shows that the multi-hop M2M network can significantly enhance coverage and the average rate of the entire network.

The work in [164], considered the problem of designing transmission strategy selection algorithm for D2D based M2M underlying cellular network. The authors proposed an evolutionary game-based algorithm to opportunistically switch the device between non-cooperative and cooperative strategies. The numerical result shows that the proposed algorithm can significantly improve system performance in terms of throughput and fairness. The authors in [166] proposed a D2D based M2M communication and offloading principle, where nearby M2M devices can communicate directly among themselves using D2D communication. Numerical result shows their proposed method provide a promising gain in terms of delay, throughput, and energy consumption for the M2M network.

7. D2D Resource Allocation and Optimization

This section systematically illustrates available literature considering their aims, problem constraints, formulated problem types, and followed solutions, which will enable us to grasp the trend of solutions for D2D resource optimization problems.

7.1. Objectives and Constraints

As can be seen from Table 10, due to the scarcity of spectrum resources, most of the available literature formulate their resource allocation optimization problem with an objective to realize efficient spectrum utilization. The author in [13, 17, 21, 22, 37, 76, 92, 105] were formulated the resource optimization problem with an objective to maximize spectrum efficiency. Particularly, in [13] the author discussed the resource allocation problem as a Stackelberg game with pricing

Table 8. Resource Optimization for D2D-based Public Safety Communication

Reference	Optimization problems	Description
[154]	non-convex problem	Proposed caching and D2D assisted communications with statistical QoS provisioning for effective and time line delivery of emergency communication.
[155]	NP complete problem	Proposed service oriented D2D communication strategy for post disaster management for improved energy consumption and packet delivery ratio.
[156]	NP optimization problem	Proposed multi antenna precoding strategy and multi hop D2D communication to provide reliable communication and extended UAV coverage for disaster relief.
[157]	Stochastic optimization problem	developed an SINR based synchronization protocol for D2D based Public Safety communications.
[158]	Stochastic optimization problem	exploited energy harvesting relaying strategy with simultaneous information and power transfer to extend lifetime of energy constrained D2D based Public Safety network.
[159]	Stackelberg game with interference pricing and energy trading	investigated a disaster management exploiting D2D cooperative communication
[160]	Analytical optimization	In order to maintain QoS requirement of emergency communication, an opportunistic multi-casting scheme is proposed for D2D based relaying scheme and to minimize delay and enhance throughput
[161]	Analytical model	Proposed cluster based MAC protocol for D2D based public safety Communications

Table 9. Resource Optimization for D2D-based M2M Communication

Reference	Optimization problems	Description
[162]	Analytical model	Exploited analytical model based MAC protocol to explore throughput performance of D2D and M2M sharing unlicensed resource.
[163]	stochastic geometry	Proposed stochastic geometry based framework and studied coverage probability and average data rate of D2D based multi-hop M2M communication and perform extensive simulations to study system performance
[164]	Evolutionary Game	Proposed evolutionary game based transmission strategy selection for D2D based M2M communication
[165]	stochastic geometry	Proposed spectrum and power efficient massive code space multiplex access .Mitigate co-channel interference to mobile user .Avoid congestion . Minimize power consumption of M2M device
[166]	Optimization Problem	Proposed multi-hop M2M communication where with nearby M2M devices communicate directly for higher resource utilization and better network performance.
[167]	Deterministic polynomial time hard	Proposed interference aware bipartite graph for D2D based M2M communication to .Minimize power consumption .Efficient resource sharing
[168]	Analytical optimization	Proposed techniques to aggregate and Trunk M2M Traffic through D2D Connection, where D2D user aggregate M2m data and supplement with its own data and send it to BS
[169]	Analytical derivation	Proposed promising resource allocation for multi-hop D2D based M2M communication to enhance end-to- end latency

to enhance the spectrum efficiency by providing services to more user equipment with limited spectrum resources. Whereas the authors in [17] propose a genetic algorithm-based method to minimize the interference and maximize the spectral efficiency. Through numerical evaluations, the authors demonstrate the performance of their proposed technique in terms of spectral efficiency and interference mitigation. The typical mathematical framework of the objective function to maximize spectrum efficiency can be shown as in 1:

$$\eta_{SE} = \text{Maximize}_{p,x} \sum_{d \in D} \sum_{r \in R} (1 + \gamma_d) \quad (1)$$

Where P and X are the power allocation vector and channel assignment matrix respectively. γ_d represent the signal quality, whereas D and R are set of D2D pair and resource blocks.

The other most common objective of D2D resource allocation based on the literature review is energy efficiency. An efficient power control technique is one approach to deal with interference between D2D and cellular users, as well as the interference between different D2D pairs sharing the same resource for both uplink and downlink cases. The authors in [11, 18, 22, 33, 38] have considered energy efficiency

Table 10. Resource Allocation in inband D2D communication: Comparison Based on Objectives and Constraints

Reference	Objectives				Constraints		
	Spectrum	Energy	Throughput	Other	SINR	Power	Other
[9]			✓		✓		
[10]		✓			✓		
[11]		✓	✓		✓		
[12]			✓		✓	✓	Spectrum
[13]	✓				✓		
[14]			✓		✓		
[15]			✓		✓		Spectrum
[16]			✓		✓	✓	
[17]	✓				✓	✓	
[18]					✓	✓	
[19]			✓			✓	Throughput
[20]			✓			✓	
[21]	✓	✓		Coverage probabilities	✓		
[22]	✓	✓			✓	✓	
[30]					✓		
[31]			✓	Users' fairness	✓		Fairness
[32]				D2D sum-rate	✓		
[33]		✓			✓	✓	Throughput
[34]			✓		✓		
[37]		✓		Delay reduction			Throughput
[38]		✓			✓	✓	Throughput
[42]	✓				✓		
[43]		✓			✓		
[44]	✓						Throughput
[45]			✓				Coverage probability
[47]			✓		✓		
[49]				Transmission rates	✓		
[50]			✓	Capacity and blocking rate		✓	
[63]				Fairnesse			Data rate
[65]			✓				QoS
[72]	✓						powers and rates
[75]	✓				✓		
[76]	✓			Sum rate of the D2D			QoS for the CUE
[79]				Sum-rate of D2D			CUE's minimum transmit rate
[80]				Bandwidth and throughput			QoS
[84]			✓				User's delay
[89]			✓				Transmission power
[90]			✓		✓		
[92]	✓						QoS and fairness
[94]				SINR distribution			Transmission power
[95]				No. of admitted D2D links			QoS
[98]				Increase frequency reuse			QoS
[99]				Ergodic sum rates			Outage probability.
[95]			✓				Quality of service
[100]	✓				✓		
[101]				Cell coverage and user satisfaction			Transmission power
[103]	✓						Outage probability
[105]	✓		✓				

as their objectives of the D2D resource allocation optimization problem. In [11], the authors formulate the resource allocation in D2D communications using the Stackelberg game with an objective to minimize total transmission power by combining how to utilize radio resources and power efficiently altogether. The authors formulate resource allocation optimization problems using the Stackelberg game theory with a single leader (Base station) and multiple followers (D2D pair). The Base station reduces interference

within the network by pricing the followers, whereas followers react to the price and find an optimal transmission power and resource block allocation in a non-cooperative manner. The proposed approach reduced the transmit power and increases throughput.

The authors in [18] formulate the resource allocation problem in the form of an iterative combinatorial auction to minimize the system power consumptions while in [22] the authors formulates the problem as a stochastic optimization model aiming to maximize

both energy and spectral efficiency concurrently, where resource allocation and power control are jointly optimized. Through theoretical investigation and numerical results, the convergence, optimality, and effectiveness of the proposed algorithms are also validated. The general objective function to maximize energy efficiency can be shown as in 2:

$$\eta_{EE} = \text{Maximiz}_{p,x} \left(\frac{\eta_{SE}}{P} \right) \quad (2)$$

Where η_{SE} is the spectral efficiency as given in 1 and P is power spent in achieving η_{SE} , which can be modeled as:

$$P = P_{PA} + P_C \quad (3)$$

Where P_{PA} represents the total power consumed by the power amplifiers at the transceiver, P_C represents the total circuit power consumed by different analog and digital signal processing circuits.

Due to the increasing demand for high capacity, most of the works in the literature focus on maximizing network throughput or data rate as their main objective in developing their resource optimization problems, as can be seen from Table 10. In fact, the problem of how to maximize network capacity at minimum cost is the question of many literatures in the area. The authors in [14] propose an algorithm based on reinforcement learning to coordinate power allocation and control interference level aiming to maximize the sum rate of D2D pairs. In [15, 16], the author address the resource allocation problem for underlay D2D pairs using matching theory. The author in [15] formulates the resource allocation optimization problem with an objective to maximize D2D throughput while imposing interference constraints to protect the cellular user. To solve the resulting nonlinear resource optimization problem, the author proposed a stable, self-organizing, and distributed solution based on the concept of matching theory. The authors formulated their system model considering the scenario where downlink resources are reused. However, downlink resources are heavily loaded than the uplink, hence reusing downlink resources is not preferable to improve the resource utilization efficiency. Also, only one D2D pair was allowed to reuse one cellular resource, hence multi-user diversity is not fully exploited. This can limit the number of served D2D pairs and spectrum efficiency, which can be improved if multiple D2D pairs are allowed to reuse the same resource.

The authors in [16] proposed cascaded channel-power allocation to maximize the sum rate of the D2D pair while guaranteeing the interference threshold to cellular users using matching-Stackelberg game theory. However, the proposed scheme can't enable D2D links to share resources with multiple cellular

users. The network capacity and spectral efficiency can be improved further by using multiuser diversity gain; where the cellular resource is shared by multiple D2D pairs and each D2D pair reuse resource from the different cellular users.

The authors in [42] considered D2D enabled mobile edge computing (MEC) system for an information-centric wireless network and studied how D2D communications can be favorable to MEC. Using a terminal device for content caching and the D2D link to help MEC node in performing data transmission can reduce download time and improve the quality of experience. On the other hand, because of spectrum reuse, serious inter-user interference occurs and can directly affect the quality of communication links. The author studied the resource allocation optimization problem with an objective to maximize spectrum efficiency and system capacity of the overall network based on a deep reinforcement learning approach.

As can be seen from Table 10, much literature takes SINR as one of their key constraints in their problem formation. The authors in [11, 12, 14–16, 20, 30] formulated their optimization problem while maintaining the SINR constraint of D2D and cellular users. In addition to SINR, there are many other constraints considered in formulating the channel power allocation optimization problems. Table 10 gives a summary of the literature considering their objectives and constraints.

7.2. Problem Type, Solution Approach and System Characteristics

This section analyzes the D2D resource allocation problem types and proposed solutions as well as characteristics of different approaches in the literature. A systematic organization of the literature available in the stated research area considering the various characteristics about system modeling, problem definition, and implementation can help researchers to understand the trend of solution approach for D2D resource optimization problems and can enable to identify ideas that have been thoroughly explored and those underexplored as a potential for further research.

As can be seen from table 11, most of the papers in the literature studied a single objective resource optimization problem, dealing with either the maximization of throughput, or spectrum efficiency or minimization of consumed energy [7-16], but authors in few other papers [11, 22] proposed a multi-objective optimization problem. As multi-objective optimization can have better fairness than a single objective, it is important to put more effort into the formulation of a multi-objective D2D resource optimization problem in order to achieve an optimum value between energy and spectrum efficiency. The most common problem

Table 11. Resource Allocation D2D communication: Comparison Based on Problem, Solution and System Characteristic

Reference	Problem type	Single/ multiple objective S/M	C/D	Single/ multi cell S/M	Uplink/ downlink U/D	Solution approach
[9]	NP-hard and combinatorial	M	C	M	U	Fractional frequency reuse Dual Lagrangian decomposition method
[10]	Convex optimization	M	C	M	D	Hungarian Method, Self-Adaptive Power Control Strategy
[11]	Multi-criteria optimization problem	M	C	S	U	Stackelberg Game
[12]	MINLP	S	D	S	U	Many-to-one matching game
[13]	Optimization problem	S	D	S	D	Stackelberg Game and Stochastic Learning Algorithm
[14]	Non-convex	S	D	S	U	Q-learning
[15]	MINLP	S	D	S	D	Matching game
[16]	MINLP	S	D	S	U	Cascaded channel-power allocation using matching theory
[17]	Non-convex problem	S	C	S	U	Optimization using genetic algorithm
[18]	MINLP	S	D	S	U	Iterative combinatorial auction
[19]	MINLP	S	D	S	U	Coalition game based RA and whale optimization based PC
[20]	Non-convex problem	S	D	S	U	Distributed clustering algorithm based on the cross-layer coalitional game
[21]	Non-convex problem	S	D	S	U	Stochastic geometry
[22]	Non-convex problem	M	C	S	U	Stochastic optimization
[31]	MINLP	S	C	S	U	D2D admission control + Hungarian Algorithm
[32]	MINLP	S	C	S	U	Lambert W function + Gale-Shapley algorithm
[34]	Optimization problem	S	D	S	D	Quantum coral reefs optimization algorithm (QCROA)
[41]	Non-convex	S	D	S	U	Successive convex approximation + dual decomposition
[43]	MINLP	S	C	S	D	Lagrange dual decomposition approach
[39]	Non linear optimization	S	C	S	U	Convex optimization methods
[45]	Optimization problem	S	C	S	U	Bio-inspired approach: Bees Life Algorithm (BLA)
[49]	MINLP	S	C	S	U	greedy based mode selection and channel allocation algorithm
[50]	Optimization problem	S	C	S	U	soft frequency reuse (SFR)
[63]	Optimization problem	S	C	S	Not stated	greedy algorithm and water filling
[65]	Optimization problem	S	C	S	D	quantum coral reefs optimization algorithm
[75]	Non-convex non-linear programming problem	S	C	S	U	Lagrangian method
[76]	Optimization problem	S	C	S	U	Joint Beamforming and Resource Allocation
[79]	Optimization problem	S	C	S	U	convex functions programming, Kuhn-Munkres algorithm
[80]	Optimization problem	S	C	S	U	predatory search algorithm
[84]	constraint optimization problem	S	C	S	U	Lagrangian approach
[89]	Optimization problem	S	C	S	U	heuristic
[90]	Centralized resource optimization problem	S	C	S	U	Overlapping coalitions
[92]	Optimization	S	C	S	U, D	graph theory
[94]	Optimization problem	S	C	S	D	power control method
[95]	Convex optimizations	S	C	S	D	Sequential Convex Programming Approach
[98]	Statistical model	S	C	S	U	interference coordination methods Blind Admission Control
[99]	Nonconvex problem	S	C	S	U	Bipartite graph Hungarian algorithm
[95]	Nonlinear fractional programming problem	S	C	S	U	First-order algorithm
[101]	Optimization problem	S	C	S	Not stated	Lyapunov optimization
[103]	Analytical optimization problem	S	C	S	U	uniform interference power (UIP) scheme
[105]	Optimization problem	S	C	S	U	Bio-inspired power control and channel allocation

(S/M :Single/multiple C/D: Centralized/distributed U/D: Uplink/downlink)

types considered in the literature include mixed-integer non-linear programming [15, 16, 18], non-convex optimization [17, 20] convex optimization [11] and stochastic optimization [21, 22]. For each problem type literature has proposed a different way of solution considering the complexity, stability,

and also its effectiveness in improving the objective function. Particularly, the author in [15] formulates the resource allocation problem as a mixed-integer nonlinear optimization problem to maximize the D2D sum rate while protecting the cellular users. Whereas the authors in [17] formulate the resource allocation

problem as a convex optimization problem to maximize the D2D sum rate while protecting the cellular users and proposed a cascaded channel-power allocation using matching theory.

Downlink or uplink resource reuse is the other essential feature regarding the system models considered in the literature. In practice, reusing uplink resources for D2D users can improve the utilization efficiency, since the uplink resources are less utilized than the downlink. In addition, when D2D pairs reuse uplink channels, interference from D2D pairs can be better treated by the base station, which is more powerful than mobile devices. Therefore, it is more efficient to reuse uplink resources. As can be seen from Table 11, most papers in the literature formulated their system models assuming that D2D communications share the uplink spectrum resource only [9, 12, 16, 32, 41], while a few papers [13, 34, 43, 94, 95] formulated their model considering the downlink spectrum resource.

8. Classification of D2D Resource Optimization: Based on Solution Approach

Most of the available literature on D2D channel-power optimization scheme focuses on in-band underlay D2D and its underlying problem of interference management, proposing techniques to coordinate, avoid, and/or mitigate interference and improve network performance. This section provides a comprehensive classification of the different resource assignment and power control optimization techniques proposed in the literature based on distance between D2D and cellular user, interference tolerance, optimization as can be dictated in Figure ??.

9. Recommendations for Future Research Direction

9.1. D2D Resource Allocation in Multi-cell Cellular Network

As it has been discussed in the previous sections, D2D resource allocations not only mitigate the harmful interference but also enable to enhance the network performance. Hence, the question of how to share the scarce resource to optimize the performance of D2D communication has got extensive research attentions. However, most of the current literature consider the resource allocation problem in the single-cell scenario, while little attention is given to optimize resource in a multi-cell scenario. In these papers, the transceiver of D2D pairs are located in the same cell. This can simplify the resource optimization problems since each D2D pair share resource within the same cell. In multi-cell D2D underlaid, besides the interference inside each cell, the resource optimization problem needs to coordinate the mutual interference between different cells as well as the handover issue. This is more

practical in emerging 5G networks and difficult to analyze as it requires coordination between different cells. Therefore, it is indispensable to have an effective solution to optimally allocate resources and maximize the performance of the network where the D2D transceivers have arbitrary location as it essential to optimize network resources and provide satisfactory experiences for cell edge users. This could be a potential research direction as it enables us to investigate and understand the practical operational efficiency of future cellular-assisted D2D communications.

9.2. User Mobility Impact on D2D Resource Allocation

Because of unpredictable user mobility, the potential D2D-enabled application and service envision highly opportunistic device contact. User mobility would affect the chances the user meets and establish a direct link, which can result in a negative impact on individual D2D link performance (duration, throughput) and the overall D2D system performance (offloading gain, device/content availability). This would result in frequent mode selection as well as resource allocation problems which can degrade the resulting system performance. However, the existing literature gives less attention to consider user mobility in resource allocation problems. The majority of the literature assumes that the base station senses the global instantaneous CSI of all the D2D and cellular links, but this assumption is not practical for the fast-moving D2D system. Therefore, one can deal the impact of user mobility on D2D resource assignment and power control to understand the practical operational efficiency of future cellular-assisted D2D systems as it may have a profound impact on the resulting system performance.

9.3. Channel Measurements

In centralized resource allocation, the central controller requires the channel gain from BS to every D2D pair, between D2D pairs and CUE as well as the gain among different D2D pairs. In the distributed case, the central controller requires the channel gain from BS to each D2D pair and each D2D pairs would require the channel gain between itself and every other D2D pairs. In both cases, a tremendous amount of resources could be utilized to estimate and feedback the channel gain, which can affect resource utilization efficiency. The required channel measurement and reporting depend on the level to which the base station is involved in the channel assignment. Most of the existing resource allocation schemes are developed under the assumption that all information required for channel assignment are available at the intended nodes, which can limit their applicability.

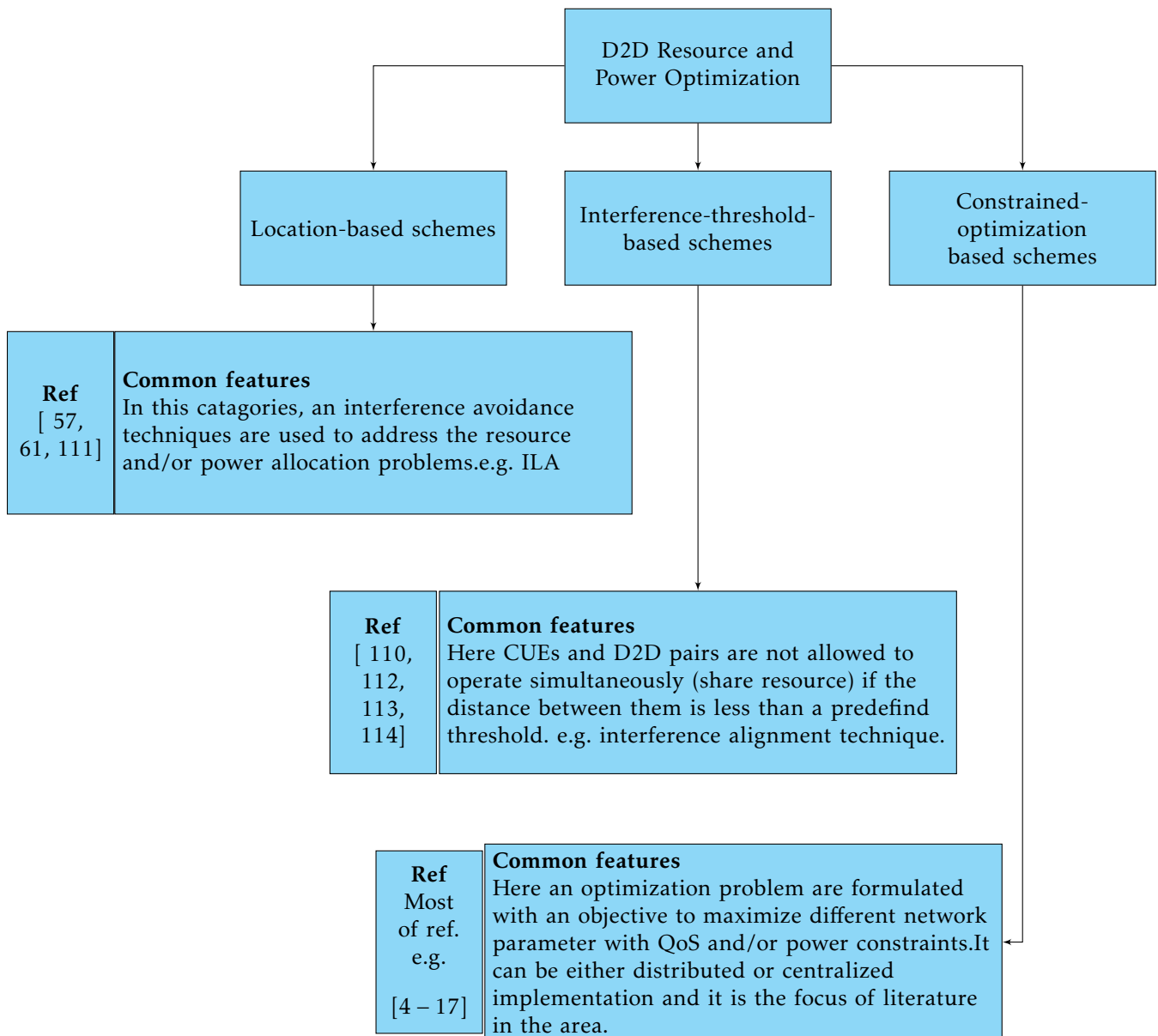

Figure 9. D2D resource assignment and power control: Solution Approach

With the densification and massive connectivity in the future, it is crucial to study the signaling overhead compared to the performance obtained and design a resource allocation scheme with limited channel state information utilizing either statistical information or link adaptation as it can significantly reduce signaling overhead and improve resource efficiency.

9.4. Multi-objective Optimization

Most of the papers in the literature studied a single objective optimization problem dealing with either maximization of spectral efficiency or minimization of consumed energy, but authors in a few other papers considered multi-objective optimization problems. As

multi-objective techniques can have better performance than single objectives, it is important to put more effort into the formation of a multi-objective resource optimization problem for D2D underlaid cellular network in order to achieve an optimum value between energy and spectrum efficiency.

9.5. D2D Resource Allocation in Heterogeneous Networks

The emerging fifth-generation network is expected to provide 1,000-times increases in network capacity and massive connectivity with low latency. To achieve these ambitious targets, heterogeneity is expected to be a key feature in 5G deployment, which incorporates

an increasing number of small cells with different transmission power and coverage, providing a high data rate. Efficient resource management and interference coordination among different nodes would become more challenging, yet essential to optimize network resources and provide a satisfactory user experience.

D2D communication works more efficiently in heterogeneous than single-cell homogeneous networks as it can save more resources, especially when the users are located at cell edges. Due to limited backhaul connection in small cell heterogeneous networks, D2D can be a promising technology for the future multi-layer heterogeneous network for optimizing spectral efficiency. But, the integration of D2D communications in a heterogeneous network would also be much more complicated because neighboring cells have to cooperate which results in many research and design challenges. Particularly, resource optimization and power control mechanism are more complicated than in the conventional homogeneous cellular network, as the resource allocation problem split from a single cell to multi-cell and the handover issue becomes more frequent.

9.6. D2D Resource Allocation in Multi-antenna Base Station

Multi-antenna BS also called massive MIMO is one of the most promising technologies proposed to achieve the envisioned requirement of future generation networks. The use of a large number of base station antennas over the number of user yield a favorable propagation where the channel vectors between the users and the BS are pairwise orthogonal so that a simple linear signal processing (linear precoding and decoding) are nearly optimal. This will enable the transmission of the cellular user data in the null space of the channels of other cellular users so that the inter-user interference can be canceled out. If we consider beamforming and/or linear detection techniques to cancel out the interference caused by the cellular transmission to D2D users, designing a cellular users precoding vector in the downlink or linear decoding matrix in the uplink so that its data is transmitted in the null space of D2D users channels would be one potential research direction to facilitate the smooth operation of D2D in the future multi-antenna cellular network. Based on the different multi-antenna transmission techniques, D2D resource assignment and precoding/ decoding vector can be jointly optimized to maximize the overall system throughput. The D2D resource assignment should also keep the interference from D2D to cellular below a certain level so that the SINR of the cellular user will meet the requirements for successful transmission. However, most of the existing literature considers the resource allocation problem in

the single-antenna BS, while little attention is paid to optimize resource in multi-antenna BS scenario.

10. Conclusion

In this paper, we have presented a comprehensive survey on D2D resource scheduling and power control-related research works, which can significantly help the research community in the area to identify the pros and cons of existing works and perform further investigation for its sustainable implementation. It first introduces the main driving factor for the wireless industry to develop network-assisted D2D communication and associated challenges. It then provides an in-depth literature survey that discusses broader features, requirements, and challenges of D2D resource allocation optimization which are largely missing in the existing survey. It gives a solid comparison on D2D spectrum optimization and power control related works by considering their problem type, solution approach, level of network involvement, their use case and system characteristics, objective and constraints to give broader insights for the readers in the area to figure out the strength and weakness of proposed solution. Based on the surveyed papers, it finally outlined potential open research issues which are believed to deserve further investigations for successful implementation of D2D in the emerging networks.

According to the surveyed paper, even though D2D is an economic and promising technology to enhance network performance, its implementation poses significant challenges pertaining to interference management. Without proper interference coordination, the efficiency of the D2D underlying cellular network may be deteriorated rather than improving. Thus, for D2D communication to be an integral technology of the emerging cellular network, researchers should overcome the associated challenges in order to completely grasp its advantage. As far as we have a limited cellular resource, the question of how to efficiently use the scarce available resource to optimize different network performance will remain the main focus of the research community in the area. For a sustainable implementation of D2D, the main research question in the literature is how to optimally allocate resources and adjust their level of transmission power to exploit frequency reuse and multi-user diversity so that one cellular user's resource can be shared by multiple D2D pairs and a D2D pair can reuse resources from different cellular users to advance network performance without compromising the performance of primary cellular users. This survey paper can help the future readers to better understand the D2D concepts and challenges and enable them to have a better understanding of future

research opportunities that have been identified in the field of D2D resource scheduling and power allocation.

References

- [1] N. Alliance, "Next generation mobile networks," 5G white paper , 1, 2015.
- [2] 5G America: Wireless Technology Evolution towards 5G: 3GPP Release 13 to Release 15 and Beyond, Feb. 2017
- [3] X. Wu et al., "FlashLinQ: A Synchronous Distributed Scheduler for Peer-to-Peer Ad Hoc Networks," in *IEEE/ACM Transactions on Networking*, vol. 21, no. 4, pp. 1215-1228, Aug. 2013.
- [4] X. Bao, Y. Lin, U. Lee, I. Rimac and R. R. Choudhury, "DataSpotting: Exploiting naturally clustered mobile devices to offload cellular traffic," 2013 Proceedings IEEE INFOCOM, Turin, 2013, pp. 420-424.
- [5] H. Nishiyama, M. Ito and N. Kato, "Relay-by-smartphone: realizing multihop device-to-device communications," in *IEEE Communications Magazine*, vol. 52, no. 4, pp. 56-65, April 2014.
- [6] S. Yu, W. Ejaz, L. Guan & A. Anpalagan. "Resource allocation schemes in D2D communications: overview, classification, and challenges." *Wireless Personal Communications*, 96(1), 303-322, 2017.
- [7] J. Liu, N. Kato, J. Ma and N. Kadowaki, "Device-to-Device Communication in LTE-Advanced Networks: A Survey," in *IEEE Communications Surveys & Tutorials*, vol. 17, no. 4, pp. 1923-1940, Fourthquarter 2015.
- [8] F. Jameel, Z. Hamid, F. Jabeen, S. Zeadally and M. A. Javed, "A Survey of Device-to-Device Communications: Research Issues and Challenges," in *IEEE Communications Surveys & Tutorials*, vol. 20, no. 3, pp. 2133-2168, thirdquarter 2018.
- [9] F. Jiang, B. C. Wang , C. Y. Sun,, Y. Liu, & X. Wang. "Resource allocation and dynamic power control for D2D communication underlying uplink multi-cell networks". *Wireless Networks*, 24(2), 549-563, 2018.
- [10] S. A. R. Naqvi et al., "Energy-Aware Radio Resource Management in D2D-Enabled Multi-Tier HetNets," in *IEEE Access*, vol. 6, pp. 16610-16622, 2018.
- [11] N. Sawyer and D. B. Smith, "Flexible Resource Allocation in Device-to-Device Communications Using Stackelberg Game Theory," in *IEEE Transactions on Communications*, vol. 67, no. 1, pp. 653-667, Jan. 2019.
- [12] Y. Yuan, T. Yang, H. Feng and B. Hu, "An Iterative Matching-Stackelberg Game Model for Channel-Power Allocation in D2D Underlaid Cellular Networks," in *IEEE Transactions on Wireless Communications*, vol. 17, no. 11, pp. 7456-7471, Nov. 2018.
- [13] S. Dominic and L. Jacob, "Distributed Resource Allocation for D2D Communications Underlying Cellular Networks in Time-Varying Environment," in *IEEE Communications Letters*, vol. 22, no. 2, pp. 388-391, Feb. 2018.
- [14] S. Toumi, M. Hamdi and M. Zaied, "An adaptive Q-learning approach to power control for D2D communications," 2018 International Conference on Advanced Systems and Electric Technologies, Hammamet, 2018, pp. 206-209.
- [15] S. M. A. Kazmi, N. H. Tran, Tai Manh Ho, Dong Kyu Lee and C. S. Hong, "Decentralized spectrum allocation in D2D underlying cellular networks," 2016 18th Asia-Pacific Network Operations and Management Symposium (APNOMS), Kanazawa, 2016, pp. 1-6.
- [16] Y. Yuan, T. Yang, Y. Xu, H. Feng and B. Hu, "A cascaded channel-power allocation for D2D underlaid cellular networks using matching theory," 2018 IEEE Wireless Communications and Networking Conference (WCNC), Barcelona, 2018, pp. 1-6.
- [17] H. Takshi, G. Doğan and H. Arslan, "Joint Optimization of Device to Device Resource and Power Allocation Based on Genetic Algorithm," in *IEEE Access*, vol. 6, pp. 21173-21183, 2018.
- [18] M. Mahfoudhi, M. Hamdi and M. Zaied, "Distributed Resource Allocation Using Iterative Combinatorial Auction for Device-to-Device Underlay Cellular Networks," 2019 15th International Wireless Communications & Mobile Computing Conference (IWCMC), Tangier, Morocco, 2019, pp. 2043-2049.
- [19] Y. Sun, F. Wang and Z. Liu, "Coalition Formation Game for Resource Allocation in D2D Uplink Underlying Cellular Networks," in *IEEE Communications Letters*, vol. 23, no. 5, pp. 888-891, May 2019.
- [20] N. Sawyer and D. B. Smith, "A Nash Stable Cross-Layer Coalitional Game for Resource Utilization in Device-to-Device Communications," in *IEEE Transactions on Vehicular Technology*, vol. 67, no. 9, pp. 8608-8622, Sept. 2018.
- [21] A. Abdallah, M. M. Mansour and A. Chehab, "Power Control and Channel Allocation for D2D Underlaid Cellular Networks," in *IEEE Transactions on Communications*, vol. 66, no. 7, pp. 3217-3234, July 2018.
- [22] Y. Hao, Q. Ni, H. Li, S. Hou and G. Min, "Interference-Aware Resource Optimization for Device-to-Device Communications in 5G Networks," in *IEEE Access*, vol. 6, pp. 78437-78452, 2018.
- [23] R. Alkurd, R. M. Shubair and I. Abualhaol, "Survey on device-to-device communications: Challenges and design issues," 2014 IEEE 12th International New Circuits and Systems Conference (NEWCAS), Trois-Rivieres, QC, 2014, pp. 361-364.
- [24] A. Asadi, Q. Wang and V. Mancuso, "A Survey on Device-to-Device Communication in Cellular Networks," in *IEEE Communications Surveys & Tutorials*, vol. 16, no. 4, pp. 1801-1819, Fourthquarter 2014.
- [25] P. Mach, Z. Becvar and T. Vanek, "In-Band Device-to-Device Communication in OFDMA Cellular Networks: A Survey and Challenges," in *IEEE Communications Surveys & Tutorials*, vol. 17, no. 4, pp. 1885-1922, Fourthquarter 2015.
- [26] C. Hsu and W. Chen, "Joint Power Control and Channel Assignment for Green Device-to-Device Communication," 2018 IEEE 16th Intl Conf on Dependable, Autonomic and Secure Computing, 16th Intl Conf on Pervasive Intelligence and Computing, 4th Intl Conf on Big Data Intelligence and Computing and Cyber Science and Technology Congress (DASC/PiCom/DataCom/CyberSciTech), Athens, 2018, pp. 881-884.
- [27] M. Hmila, M. Fernández-Veiga and M. Rodríguez-Pérez, "Matching-Theory-Based Resource Allocation for Underlay Device to Multi-Device Communications," 2018

- 14th International Conference on Wireless and Mobile Computing, Networking and Communications (WiMob), Limassol, 2018, pp. 28-35.
- [28] M. Hmila, M. Fernandez-Veiga and M. Rodriguez-Perez, "Distributed Resource Allocation Approach For Device-to-Device Multicast Communications," 2018 14th International Conference on Wireless and Mobile Computing, Networking and Communications (WiMob), Limassol, 2018, pp. 1-8.
- [29] N. Putjaika, P. Phunchongharn, K. Akkarajitsakul and U. Taetragool, "Joint Mode Selection and Resource Allocation for Relay-Assisted Device-to-Device Networks," 2018 28th International Telecommunication Networks and Applications Conference (ITNAC), Sydney, NSW, 2018, pp. 1-6.
- [30] S. Cicalò and V. Tralli, "QoS-Aware Admission Control and Resource Allocation for D2D Communications Underlying Cellular Networks," in *IEEE Transactions on Wireless Communications*, vol. 17, no. 8, pp. 5256-5269, Aug. 2018.
- [31] X. Li, R. Shankaran, M. A. Orgun, G. Fang and Y. Xu, "Resource Allocation for Underlay D2D Communication With Proportional Fairness," in *IEEE Transactions on Vehicular Technology*, vol. 67, no. 7, pp. 6244-6258, July 2018.
- [32] R. Gour and A. Tyagi, "QoS Aware Channel Selection and Power Allocation for Device-to-Device Communication," 2018 IEEE International Conference on Advanced Networks and Telecommunications Systems (ANTS), Indore, India, 2018, pp. 1-6.
- [33] S. Liu, Y. Wu, L. Li, X. Liu and W. Xu, "A Two-Stage Energy-Efficient Approach for Joint Power Control and Channel Allocation in D2D Communication," in *IEEE Access*, vol. 7, pp. 16940-16951, 2019.
- [34] H. Gao, S. Zhang, Y. Su and M. Diao, "Joint Resource Allocation and Power Control Algorithm for Cooperative D2D Heterogeneous Networks," in *IEEE Access*, vol. 7, pp. 20632-20643, 2019.
- [35] Z. Zhang, Y. Wu, X. Chu and J. Zhang, "Resource Allocation and Power Control for D2D Communications to Prolong the Overall System Survival Time of Mobile Cells," in *IEEE Access*, vol. 7, pp. 17111-17124, 2019.
- [36] B. Chen, J. Liu, X. Yang, L. Xie and Y. Li, "Resource Allocation for Energy Harvesting-Powered D2D Communications Underlying NOMA-Based Networks," in *IEEE Access*, vol. 7, pp. 61442-61451, 2019.
- [37] Y. Tao and G. Chen, "An Auction-based Channel Allocation and Power Control Algorithm for V2V Communications in VANETs," 2019 34rd Youth Academic Annual Conference of Chinese Association of Automation (YAC), Jinzhou, China, 2019, pp. 671-675.
- [38] Z. Zhang, Y. Wu, X. Chu and J. Zhang, "Resource Allocation and Power Control to Maximize the Overall System Survival Time for Mobile Cells With a D2D Underlay," in *IEEE Communications Letters*, vol. 23, no. 5, pp. 880-883, May 2019.
- [39] X. Shi, D. Wu, C. Yue, C. Wan and X. Guan, "Resource Allocation for Covert Communication in D2D Content Sharing: A Matching Game Approach," in *IEEE Access*, vol. 7, pp. 72835-72849, 2019.
- [40] Y. Wang, C. Xu, Y. He and Z. Zhou, "Low-Complexity Cross-Layer Resource Allocation for Low-Latency D2D-Based Relay Networks," 2019 15th International Wireless Communications & Mobile Computing Conference (IWCMC), Tangier, Morocco, 2019, pp. 1619-1624.
- [41] Z. Liu, Y. Xie, K. Y. Chan, K. Ma and X. Guan, "Chance-Constrained Optimization in D2D-Based Vehicular Communication Network," in *IEEE Transactions on Vehicular Technology*, vol. 68, no. 5, pp. 5045-5058, May 2019.
- [42] D. Wang, H. Qin, B. Song, X. Du and M. Guizani, "Resource Allocation in Information-Centric Wireless Networking With D2D-Enabled MEC: A Deep Reinforcement Learning Approach," in *IEEE Access*, vol. 7, pp. 114935-114944, 2019.
- [43] Y. Liu, Y. Wang, R. Sun, S. Meng and R. Su, "Energy Efficient Downlink Resource Allocation for D2D-Assisted Cellular Networks With Mobile Edge Caching," in *IEEE Access*, vol. 7, pp. 2053-2067, 2019.
- [44] M. Anbiyaei, K. Faez and M. Najimi, "Energy-Efficient resource allocation for device-to-device underlay communications in cellular networks," in *IET Signal Processing*, vol. 13, no. 6, pp. 633-639, 8 2019.
- [45] M. K. Benbraika, S. Bitam and A. Mellouk, "Joint resource allocation and power control based on Bee Life Algorithm for D2D Communication," 2019 IEEE Wireless Communications and Networking Conference (WCNC), Marrakesh, Morocco, 2019, pp. 1-6.
- [46] Y. Tao and G. Chen, "An Auction-based Channel Allocation and Power Control Algorithm for V2V Communications in VANETs," 2019 34rd Youth Academic Annual Conference of Chinese Association of Automation (YAC), Jinzhou, China, 2019, pp. 671-675.
- [47] S. Selmi and R. Bouallègue, "Interference and power management algorithm for D2D communications underlay 5G cellular network," 2019 International Conference on Wireless and Mobile Computing, Networking and Communications (WiMob), Barcelona, Spain, 2019, pp. 1-8.
- [48] X. Shi, D. Wu, C. Yue, C. Wan and X. Guan, "Resource Allocation for Covert Communication in D2D Content Sharing: A Matching Game Approach," in *IEEE Access*, vol. 7, pp. 72835-72849, 2019.
- [49] C. Tian, Z. Qian, X. Wang and L. Hu, "Analysis of Joint Relay Selection and Resource Allocation Scheme for Relay-Aided D2D Communication Networks," in *IEEE Access*, vol. 7, pp. 142715-142725, 2019.
- [50] M. Li, "Soft Frequency Reuse-Based Resource Allocation for D2D Communications Using Both Licensed and Unlicensed Bands," 2019 Eleventh International Conference on Ubiquitous and Future Networks (ICUFN), Zagreb, Croatia, 2019, pp. 384-386.
- [51] S. Ali, et al. "Energy-efficient RRH-association and resource allocation in D2D enabled multi-tier 5G C-RAN." *Telecommunication Systems* 2019: 1-15.
- [52] S. Sharma, and S. Brahmjit. "Coalition Game-Based Strategy for Resource Allocation and Transmit Power Control in D2D Communication." *National Academy Science Letters*, 2019: 1-3.
- [53] K. K. Nguyen, T. Q. Duong, N. A. Vien, N. Le-Khac and L. D. Nguyen, "Distributed Deep Deterministic Policy Gradient for Power Allocation Control in D2D-Based V2V

- Communications," in *IEEE Access*, vol. 7, pp. 164533-164543, 2019.
- [54] H. Sun, D. Zhai, Z. Zhang, J. Du and Z. Ding, "Channel Allocation and Power Control for Device-to-Device Communications Underlying Cellular Networks Incorporated With Non-Orthogonal Multiple Access," in *IEEE Access*, vol. 7, pp. 168593-168605, 2019.
- [55] M. Zeng, Y. Luo and H. Jiang, "Energy Efficient Resource Allocation for Wireless Power Transfer-Supported D2D Communication With Battery," in *IEEE Access*, vol. 7, pp. 185666-185676, 2019.
- [56] M. Zeng, Y. Luo and H. Jiang, "Energy Efficient Resource Allocation for Wireless Power Transfer-Supported D2D Communication With Battery," in *IEEE Access*, vol. 7, pp. 185666-185676, 2019.
- [57] C. Yi, S. Huang and J. Cai, "Joint Resource Allocation for Device-to-Device Communication Assisted Fog Computing," in *IEEE Transactions on Mobile Computing*.
- [58] M.Ahmad, N.Muhammad and I.Muhammad, "Estimation of Distribution Algorithm for Joint Resource Management in D2D Communication." *Wireless Personal Communications* 108.2, 2019: 1113-1129.
- [59] B. Chen, J. Liu, X. Yang, L. Xie and Y. Li, "Resource Allocation for Energy Harvesting-Powered D2D Communications Underlying NOMA-Based Networks," in *IEEE Access*, vol. 7, pp. 61442-61451, 2019.
- [60] Y. Cheng, F. Wu, X. Huang and S. Leng, "A minimum data-rate guaranteed joint resource allocation scheme for D2D communication system," 2017 IEEE/CIC International Conference on Communications in China (ICCC), Qingdao, pp. 1-6, 2017.
- [61] S.Dhilipkumar, C. Arunachalaperumal, and K. Thanigaivelu, "A Comparative Study of Resource Allocation Schemes for D2D Networks Underlay Cellular Networks." *Wireless Personal Communications* 106.3: 1075-1087, 2019.
- [62] S.Dominic, and J.Lillykutty, "Distributed interference-aware admission control and resource allocation for underlying D2D communications in cellular networks." *Sādhanā* 44.6: 138, 2019.
- [63] M.Elshierief, E.Mohamed and A.Mohammed, "Resource and power allocation for achieving rate fairness in D2D communications overlaying cellular networks." *Wireless Networks* 25.7, 2019: 4049-4058.
- [64] L. Feng, Q. Yang, K. Kim and K. S. Kwak, "Two-Timescale Resource Allocation for Wireless Powered D2D Communications With Self-Interested Nodes," in *IEEE Access*, vol. 7, pp. 10857-10869, 2019.
- [65] H. Gao, S. Zhang, Y. Su and M. Diao, "Joint Resource Allocation and Power Control Algorithm for Cooperative D2D Heterogeneous Networks," in *IEEE Access*, vol. 7, pp. 20632-20643, 2019.
- [66] Z.Gu, P.Xu, G.Wu & H.Liu, "Resource Allocation Scheme for D2D Communication Based on ILA," Springer, Cham, In International Conference on Ad Hoc Networks pp. 39-48, 2018, September.
- [67] F. Hajiaghajani, R. Davoudi and M. Rasti, "Energy efficient resource allocation and admission control for D2D-aided collaborative mobile clouds," 2017 15th International Symposium on Modeling and Optimization in Mobile, Ad Hoc, and Wireless Networks (WiOpt), Paris, 2017, pp. 1-8.
- [68] M. Hamdi, D. Yuan and M. Zaided, "GA-based scheme for fair joint channel allocation and power control for underlying D2D multicast communications," 2017 13th International Wireless Communications and Mobile Computing Conference (IWCMC), Valencia, 2017, pp. 446-451.
- [69] D. Hamza and J. S. Shamma, "Many-to-one blind matching for device-to-device communications," 2017 IEEE 56th Annual Conference on Decision and Control (CDC), Melbourne, VIC, 2017, pp. 4988-4993.
- [70] H.Hussein, A.Elsayed & M.El-kader, "Intensive Benchmarking of D2D communication over 5G cellular networks: prototype, integrated features, challenges, and main applications," *Wireless Networks*, 1-20, 2019.
- [71] A. Ibrahim, T. M. N. Ngatched and O. A. Dobre, "Optimal Interference Management, Power Control and Routing in Multihop D2D Cellular Systems," 2019 IEEE Wireless Communications and Networking Conference (WCNC), Marrakesh, Morocco, 2019, pp. 1-8.
- [72] T. B. Iliiev, G. Y. Mihaylov, E. P. Ivanova and I. S. Stoyanov, "Power control schemes for device-to-device communications in 5G mobile network," 2017 40th International Convention on Information and Communication Technology, Electronics and Microelectronics (MIPRO), Opatija, 2017, pp. 416-419.
- [73] J. Iqbal, M. A. Iqbal, A. Ahmad, M. Khan, A. Qamar and K. Han, "Comparison of Spectral Efficiency Techniques in Device-to-Device Communication for 5G," in *IEEE Access*, vol. 7, pp. 57440-57449, 2019.
- [74] K.S.Kasi, I.H.Naqvi, K.M.Kasi & F.Yaseen, "Interference management in dense inband D2D network using spectral clustering & dynamic resource allocation," *Wireless Networks*, 25(7), 4431-4441, 2019.
- [75] P.Khuntia & R.Hazra, "QOS aware channel and power allocation scheme for D2D enabled cellular networks," *Telecommunication Systems*, 72(4), 543-554, 2019.
- [76] M. Ku and J. Lai, "Joint Beamforming and Resource Allocation for Wireless-Powered Device-to-Device Communications in Cellular Networks," in *IEEE Transactions on Wireless Communications*, vol. 16, no. 11, pp. 7290-7304, Nov. 2017.
- [77] F. C.Kuo, H. C.Wang, K. CTing, J. H.Xu & C. C.Tseng, "Resource Reuse for D2D Communication in LTE Networks by Efficient Grouping. *Wireless Personal Communications*," 106(1), 135-150, 2019.
- [78] C. B.Le & D. T.Do, "Joint evaluation of imperfect SIC and fixed power allocation scheme for wireless powered D2D-NOMA networks with multiple antennas at base station," *Wireless Networks*, 25(8), 5069-5081, 2019.
- [79] S.Li, Q.Ni, Y. Sun & G.Min, "Resource allocation for weighted sum-rate maximization in multi-user full-duplex device-to-device communications: Approaches for perfect and statistical CSIs," *IEEE Access*, 5, 27229-27241, 2017.
- [80] X.Li, Y.Sun, L.Zhou, Y.Xu & S.Zhou, "A resource allocation scheme based on predatory search algorithm for ultra-dense D2D communications," *Wireless Networks*, 1-9, 2019.
- [81] F. Librino and G. Quer, "Channel, Mode and Power Optimization for non-Orthogonal D2D Communications:

- a Hybrid Approach," in IEEE Transactions on Cognitive Communications and Networking.
- [82] Z. Lin, D. Pan and H. Song, "Energy-Efficiency-Aimed Radio Resource Scheduling for D2D Communications Underlying Cellular Network," 2019 IEEE International Conference on Smart Internet of Things (SmartIoT), Tianjin, China, 2019, pp. 14-21.
- [83] S. Lv, X. Wang, X. Meng, Z. Zhang and K. Long, "Energy-efficient joint power control and resource allocation for D2D-aided heterogeneous networks," 2017 IEEE/CIC International Conference on Communications in China (ICCC), Qingdao, 2017, pp. 1-6.
- [84] X. Mi, L. Xiao, M. Zhao, X. Xu and J. Wang, "Statistical QoS-Driven Resource Allocation and Source Adaptation for D2D Communications Underlying OFDMA-Based Cellular Networks," in IEEE Access, vol. 5, pp. 3981-3999, 2017.
- [85] D. D. Ningombam and S. Shin, "Radio resource allocation and power control scheme to mitigate interference in device-to-device communications underlying LTE-A uplink cellular networks," 2017 International Conference on Information and Communication Technology Convergence (ICTC), Jeju, 2017, pp. 961-963.
- [86] Hussein T. Mouftah; Melike Erol-Kantarci; Mubashir Husain Rehmani, "LTE-D2D Communication for Power Distribution Grid: Resource Allocation for Time-Critical Applications," in Transportation and Power Grid in Smart Cities: Communication Networks and Services , , Wiley, 2019, pp.21-67
- [87] H. Peng et al., "Resource allocation for D2D-enabled inter-vehicle communications in multiplatoons," 2017 IEEE International Conference on Communications (ICC), Paris, 2017, pp. 1-6.
- [88] H. Peng et al., "Resource Allocation for Cellular-based Inter-Vehicle Communications in Autonomous Multiplatoons," in IEEE Transactions on Vehicular Technology, vol. 66, no. 12, pp. 11249-11263, Dec. 2017.
- [89] A. Ramamurthy, V.Sathya, S.Ghosh, A.Franklin & B.Tamma, "Dynamic power control and scheduling in full duplex cellular network with d2d," Wireless Personal Communications, 104(2), 695-726, 2019.
- [90] S. Sharma & B. Singh, "Overlapping coalition-based resource and power allocation for enhanced performance of underlying D2D communication," Arabian Journal for Science and Engineering, 44(3), 2379-2388, 2019.
- [91] Y. Sun, F. Wang and Z. Liu, "Coalition Formation Game for Resource Allocation in D2D Uplink Underlying Cellular Networks," in IEEE Communications Letters, vol. 23, no. 5, pp. 888-891, May 2019.
- [92] Z.Sun & D. Yang, "A D2D Wireless Resource Allocation Scheme Based on Overall Fairness," 3D Research, 10(2), 20, 2019.
- [93] Y. Sun, W. Wu, X. Zuo & Z. Liu, " A tradeoff between throughput and energy efficiency for D2D underlying communication systems," Telecommunication Systems, 72(4), 633-639, 2019.
- [94] M. Susanto, H. Fitriawan, A. Abadi and Herlinawati, "On the reduction of interference effect using power control for device-to-device communication underlying cellular communication network," 2017 International Conference on Electrical Engineering and Computer Science (ICECOS), Palembang, 2017, pp. 28-32.
- [95] R. Tang, J. Zhao, H. Qu and Z. Zhang, "User-Centric Joint Admission Control and Resource Allocation for 5G D2D Extreme Mobile Broadband: A Sequential Convex Programming Approach," in IEEE Communications Letters, vol. 21, no. 7, pp. 1641-1644, July 2017.
- [96] T. Thepsongkroh, P. Phunchongharn and K. Akkarajitsakul, "A Game Theoretical Resource Allocation for Relay-Assisted Device-to-Device Communication Networks," 2017 International Conference on Information, Communication and Engineering (ICICE), Xiamen, 2017, pp. 484-487.
- [97] U. S. Vaishnav and M. Panda, "Resource allocation for device-to-device (d2d) communication in underlying cellular network," 2017 International Conference on Advances in Computing, Communications and Informatics (ICACCI), Udupi, 2017, pp. 1424-1438.
- [98] D. Verenzuela and G. Miao, "Scalable D2D Communications for Frequency Reuse » 1 in 5G," in IEEE Transactions on Wireless Communications, vol. 16, no. 6, pp. 3435-3447, June 2017.
- [99] L. Wang, H. Tang, H. Wu and G. L. Stüber, "Resource Allocation for D2D Communications Underlay in Rayleigh Fading Channels," in IEEE Transactions on Vehicular Technology, vol. 66, no. 2, pp. 1159-1170, Feb. 2017.
- [100] B. Chen, J. Liu, X. Yang, L. Xie and Y. Li, "Resource Allocation for Energy Harvesting-Powered D2D Communications Underlying NOMA-Based Networks," in IEEE Access, vol. 7, pp. 61442-61451, 2019.
- [101] Y. Wang, Y. He, C. Xu, Z. Zhou, S. Mumtaz, J. Rodriguez & H. Pervaiz, "Joint rate control and power allocation for low-latency reliable D2D-based relay network," EURASIP Journal on Wireless Communications and Networking, 2019(1), 111.
- [102] G. Wang, X. Yu & T. Teng, "Energy-Efficient Power Allocation Scheme for Uplink Distributed Antenna System with D2D Communication," Mobile Networks and Applications, 1-8, 2019.
- [103] A. M. Waswa, D. M. Soleymani, S. Mwanje, J. Mueckenheim and A. Mitschele-Thiel, "Multiple resource reuse for D2D communication with uniform interference in 5G cellular networks," 2017 IEEE 28th Annual International Symposium on Personal, Indoor, and Mobile Radio Communications (PIMRC), Montreal, QC, 2017, pp. 1-7.
- [104] H. Xu, W. Xu, Z. Yang, Y. Pan, J. Shi and M. Chen, "Energy-Efficient Resource Allocation in D2D Underlaid Cellular Uplinks," in IEEE Communications Letters, vol. 21, no. 3, pp. 560-563, March 2017.
- [105] J. Xu, C. Guo, & J. Yang, "Bio-inspired power control and channel allocation for cellular networks with D2D communications," Wireless Networks, 25(3), 1273-1288, 2019.
- [106] Z. Zhang, Y. Wu, X. Chu and J. Zhang, "Resource Allocation and Power Control for D2D Communications to Prolong the Overall System Survival Time of Mobile Cells," in IEEE Access, vol. 7, pp. 17111-17124, 2019.
- [107] P. Zhao, L. Feng, P. Yu, W. Li and X. Qiu, "A Social-Aware Resource Allocation for 5G Device-to-Device Multicast Communication," in IEEE Access, vol. 5, pp.

- 15717-15730, 2017.
- [108] Z. Zhou, C. Gao, C. Xu, T. Chen, D. Zhang and S. Mumtaz, "Energy-Efficient Stable Matching for Resource Allocation in Energy Harvesting-Based Device-to-Device Communications," in *IEEE Access*, vol. 5, pp. 15184-15196, 2017.
- [109] I. T. Union, "Imt traffic estimates for the years 2020 to 2030," Report ITU-R M. 2370-0, ITU-R Radiocommunication Sector of ITU, 2015.
- [110] D. Zhang, X. Liao, J. Deng and W. Wang, "Interference coordination mechanism for device-to-device communication in uplink period underlying cellular networks," 2012 International Conference on Wireless Communications and Signal Processing (WCSP), Huangshan, 2012, pp. 1-5.
- [111] H. Min, J. Lee, S. Park and D. Hong, "Capacity Enhancement Using an Interference Limited Area for Device-to-Device Uplink Underlying Cellular Networks," in *IEEE Transactions on Wireless Communications*, vol. 10, no. 12, pp. 3995-4000, December 2011.
- [112] E. Zihan, K. W. Choi and D. I. Kim, "Distributed Random Access Scheme for Collision Avoidance in Cellular Device-to-Device Communication," in *IEEE Transactions on Wireless Communications*, vol. 14, no. 7, pp. 3571-3585, July 2015.
- [113] S. Xu, H. Wang, T. Chen, Q. Huang and T. Peng, "Effective Interference Cancellation Scheme for Device-to-Device Communication Underlying Cellular Networks," 2010 IEEE 72nd Vehicular Technology Conference - Fall, Ottawa, ON, 2010, pp. 1-5.
- [114] S. Xu and K. S. Kwak, "Effective Interference Coordination for D2D Underlying LTE Networks," 2014 IEEE 79th Vehicular Technology Conference (VTC Spring), Seoul, 2014, pp. 1-5.
- [115] Jayakumar, S., S. N. A review on resource allocation techniques in D2D communication for 5G and B5G technology. *Peer-to-Peer Netw. Appl.* (2020). <https://doi.org/10.1007/s12083-020-00962-x>
- [116] D. M. Soleymani, M. R. Gholami, J. Mueckenheim and A. Mitschele-Thiel, "Dedicated Sub-Granting Radio Resource in Overlay D2D Communication," 2019 IEEE 30th Annual International Symposium on Personal, Indoor and Mobile Radio Communications (PIMRC), Istanbul, Turkey, 2019, pp. 1-7, doi: 10.1109/PIMRC.2019.8904179.
- [117] P. Mukherjee and S. Mitra, "Efficient D2D couple scheduling in overlay cellular network," 2017 International Conference on Wireless Communications, Signal Processing and Networking (WiSPNET), Chennai, 2017, pp. 401-408, doi: 10.1109/WiSPNET.2017.8299787.
- [118] Q. Wu, G. Y. Li, W. Chen and D. W. K. Ng, "Energy-Efficient D2D Overlaying Communications With Spectrum-Power Trading," in *IEEE Transactions on Wireless Communications*, vol. 16, no. 7, pp. 4404-4419, July 2017, doi: 10.1109/TWC.2017.2698032.
- [119] K. Wu and M. Jiang, "Joint Resource Efficiency Optimisation for Overlay Device-to-Device Retransmissions," 2017 IEEE 85th Vehicular Technology Conference (VTC Spring), Sydney, NSW, 2017, pp. 1-5, doi: 10.1109/VTC-Spring.2017.8108258.
- [120] A. Abrardo and M. Moretti, "Distributed power allocation for D2D communications overlaying OFDMA networks," 2017 IEEE International Conference on Communications (ICC), Paris, 2017, pp. 1-6, doi: 10.1109/ICC.2017.7996668.
- [121] J. Liu, J. Dai, Y. Kawamoto and N. Kato, "Optimizing Channel Allocation for D2D Overlaying Multi-Channel Downlink Cellular Networks," 2016 IEEE 84th Vehicular Technology Conference (VTC-Fall), Montreal, QC, 2016, pp. 1-5, doi: 10.1109/VTCFall.2016.7881139.
- [122] J. Dai, J. Liu, Y. Shi, S. Zhang and J. Ma, "Analytical Modeling of Resource Allocation in D2D Overlaying Multihop Multichannel Uplink Cellular Networks," in *IEEE Transactions on Vehicular Technology*, vol. 66, no. 8, pp. 6633-6644, Aug. 2017, doi: 10.1109/TVT.2017.2675451.
- [123] J. Liu, J. Dai, N. Kato and N. Ansari, "Optimizing Uplink Resource Allocation for D2D Overlaying Cellular Networks with Power Control," 2016 IEEE Global Communications Conference (GLOBECOM), Washington, DC, 2016, pp. 1-6, doi: 10.1109/GLOCOM.2016.7842111.
- [124] M. Abrar and X. Gui, "Maximizing sum-rate for cellular networks with overlay D2D communication," 2016 SAI Computing Conference (SAI), London, 2016, pp. 919-923, doi: 10.1109/SAI.2016.7556090.
- [125] K. Yang, S. Martin, L. Boukhatem, J. Wu and X. Bu, "Energy-Efficient Resource Allocation for Device-to-Device Communications Overlaying LTE Networks," 2015 IEEE 82nd Vehicular Technology Conference (VTC2015-Fall), Boston, MA, 2015, pp. 1-6, doi: 10.1109/VTC-Fall.2015.7390922.
- [126] J. Lyu, Y. H. Chew and W. Wong, "A Stackelberg Game Model for Overlay D2D Transmission With Heterogeneous Rate Requirements," in *IEEE Transactions on Vehicular Technology*, vol. 65, no. 10, pp. 8461-8475, Oct. 2016, doi: 10.1109/TVT.2015.2511924.
- [127] S. N. Swain, S. Mishra and C. S. R. Murthy, "A novel spectrum reuse scheme for interference mitigation in a dense overlay D2D network," 2015 IEEE 26th Annual International Symposium on Personal, Indoor, and Mobile Radio Communications (PIMRC), Hong Kong, 2015, pp. 1201-1205, doi: 10.1109/PIMRC.2015.7343481.
- [128] J. Liu, S. Zhang, H. Nishiyama, N. Kato and J. Guo, "A stochastic geometry analysis of D2D overlaying multi-channel downlink cellular networks," 2015 IEEE Conference on Computer Communications (INFOCOM), Kowloon, 2015, pp. 46-54, doi: 10.1109/INFOCOM.2015.7218366.
- [129] B. Cho, K. Koufos and R. Jäntti, "Spectrum allocation and mode selection for overlay D2D using carrier sensing threshold," 2014 9th International Conference on Cognitive Radio Oriented Wireless Networks and Communications (CROWNCOM), Oulu, 2014, pp. 26-31.
- [130] S. Xiao, W. Li, L. Yang and Z. Wen, "Graph-Coloring Based Spectrum Sharing for V2V communication," 2020 International Conference on UK-China Emerging Technologies (UCET), Glasgow, United Kingdom, 2020, pp. 1-4, doi: 10.1109/UCET51115.2020.9205455.
- [131] G. Sun, G. O. Boateng, D. Ayepah-Mensah, G. Liu and J. Wei, "Autonomous Resource Slicing for Virtualized Vehicular Networks With D2D Communications Based on Deep Reinforcement Learning," in *IEEE Systems*

- Journal, vol. 14, no. 4, pp. 4694-4705, Dec. 2020, doi: 10.1109/JSYST.2020.2982857.
- [132] Y. Liu et al., "Secrecy Rate Maximization via Radio Resource Allocation in Cellular Underlying V2V Communications," in *IEEE Transactions on Vehicular Technology*, vol. 69, no. 7, pp. 7281-7294, July 2020, doi: 10.1109/TVT.2020.2986088.
- [133] X. Li, L. Ma, Y. Xu and R. Shankaran, "Resource Allocation for D2D-Based V2X Communication With Imperfect CSI," in *IEEE Internet of Things Journal*, vol. 7, no. 4, pp. 3545-3558, April 2020, doi: 10.1109/JIOT.2020.2973267.
- [134] K. K. Nguyen, T. Q. Duong, N. A. Vien, N. Le-Khac and L. D. Nguyen, "Distributed Deep Deterministic Policy Gradient for Power Allocation Control in D2D-Based V2V Communications," in *IEEE Access*, vol. 7, pp. 164533-164543, 2019, doi: 10.1109/ACCESS.2019.2952411.
- [135] C. He, Q. Chen, C. Pan, X. Li and F. Zheng, "Resource Allocation Schemes Based on Coalition Games for Vehicular Communications," in *IEEE Communications Letters*, vol. 23, no. 12, pp. 2340-2343, Dec. 2019, doi: 10.1109/LCOMM.2019.2943316.
- [136] X. Li, Y. Sun, L. Zhou, A. Qi and S. Zhou, "A Resource Allocation Scheme Based on Immune Algorithm for D2D-Based Vehicular Communication Networks," in *IEEE Access*, vol. 7, pp. 122536-122543, 2019, doi: 10.1109/ACCESS.2019.2938211.
- [137] Z. Liu, Y. Xie, K. Y. Chan, K. Ma and X. Guan, "Chance-Constrained Optimization in D2D-Based Vehicular Communication Network," in *IEEE Transactions on Vehicular Technology*, vol. 68, no. 5, pp. 5045-5058, May 2019, doi: 10.1109/TVT.2019.2904291.
- [138] M. Wu, Y. Ren, P. Wang, C. Wang and Y. Ji, "Location-Partition-Based Resource Allocation in D2D-Supported Vehicular Communication Networks," 2018 IEEE 87th Vehicular Technology Conference (VTC Spring), Porto, 2018, pp. 1-6, doi: 10.1109/VTCSpring.2018.8417668.
- [139] N. Yu, J. Mei, L. Zhao, K. Zheng and H. Zhao, "Radio resource allocation for D2D-based V2V communications with Lyapunov optimization," 2017 IEEE/CIC International Conference on Communications in China (ICCC), Qingdao, 2017, pp. 1-6, doi: 10.1109/ICCCChina.2017.8330396.
- [140] J. Mei, K. Zheng, L. Zhao, Y. Teng and X. Wang, "A Latency and Reliability Guaranteed Resource Allocation Scheme for LTE V2V Communication Systems," in *IEEE Transactions on Wireless Communications*, vol. 17, no. 6, pp. 3850-3860, June 2018, doi: 10.1109/TWC.2018.2816942.
- [141] W. Sun, D. Yuan, E. G. Ström and F. Brännström, "Cluster-Based Radio Resource Management for D2D-Supported Safety-Critical V2X Communications," in *IEEE Transactions on Wireless Communications*, vol. 15, no. 4, pp. 2756-2769, April 2016, doi: 10.1109/TWC.2015.2509978.
- [142] V. K. Shrivastava, R. Raj and L. Pathak, "A Novel Caching Framework for Mobile Social Networks in 5G and Beyond," 2020 IEEE 3rd 5G World Forum (5GWF), Bangalore, India, 2020, pp. 63-68, doi: 10.1109/5GWF49715.2020.9221243.
- [143] S. S. Kafiloğlu, G. Gür and F. Alagöz, "Cooperative Caching and Video Characteristics in D2D Edge Networks," in *IEEE Communications Letters*, vol. 24, no. 11, pp. 2647-2651, Nov. 2020, doi: 10.1109/LCOMM.2020.3009279.
- [144] H. Huang, B. Liu, L. Chen, W. Xiang, M. Hu and Y. Tao, "D2D-Assisted VR Video Pre-Caching Strategy," in *IEEE Access*, vol. 6, pp. 61886-61895, 2018, doi: 10.1109/ACCESS.2018.2868766.
- [145] Y. Liu, A. M. A. Elman Bashar, B. Wu and H. Wu, "Delay-Constrained Profit Maximization for Data Deposition in Mobile Opportunistic Device-to-Device Networks," 2018 IEEE 19th International Symposium on "A World of Wireless, Mobile and Multimedia Networks" (WoWMoM), Chania, 2018, pp. 1-10, doi: 10.1109/WoWMoM.2018.8449735.
- [146] W. Song and Y. Zhao, "Efficient Interference-Aware D2D Pairing for Collaborative Data Dissemination," 2018 IEEE International Conference on Communications (ICC), Kansas City, MO, 2018, pp. 1-6, doi: 10.1109/ICC.2018.8422115.
- [147] Y. Zhao and W. Song, "Energy-Aware Incentivized Data Dissemination via Wireless D2D Communications With Weighted Social Communities," in *IEEE Transactions on Green Communications and Networking*, vol. 2, no. 4, pp. 945-957, Dec. 2018, doi: 10.1109/TGCN.2018.2847451.
- [148] B. K. Saha and S. Misra, "D2D Opportunistic Local Content Dissemination Sans Location Sharing," in *IEEE Transactions on Vehicular Technology*, vol. 67, no. 7, pp. 6461-6468, July 2018, doi: 10.1109/TVT.2018.2805227.
- [149] W. Song, Y. Zhao and W. Zhuang, "Stable Device Pairing for Collaborative Data Dissemination With Device-to-Device Communications," in *IEEE Internet of Things Journal*, vol. 5, no. 2, pp. 1251-1264, April 2018, doi: 10.1109/JIOT.2018.2800904.
- [150] Y. Zhao and W. Song, "A Coalitional Graph Game for Device-to-Device Data Dissemination with Power Budget Constraints," 2017 IEEE Wireless Communications and Networking Conference (WCNC), San Francisco, CA, 2017, pp. 1-6, doi: 10.1109/WCNC.2017.7925488.
- [151] Y. Zhao and W. Song, "Social-Aware Data Dissemination via Opportunistic Device-to-Device Communications," 2016 IEEE 84th Vehicular Technology Conference (VTC-Fall), Montreal, QC, 2016, pp. 1-6, doi: 10.1109/VTCFall.2016.7881227.
- [152] X. Zhu, Y. Li, D. Jin and J. Lu, "Contact-Aware Optimal Resource Allocation for Mobile Data Offloading in Opportunistic Vehicular Networks," in *IEEE Transactions on Vehicular Technology*, vol. 66, no. 8, pp. 7384-7399, Aug. 2017, doi: 10.1109/TVT.2017.2668396.
- [153] Y. Liu, A. M. A. E. Bashar, Fan Li, Y. Wang and Kun Liu, "Multi-copy data dissemination with probabilistic delay constraint in mobile opportunistic device-to-device networks," 2016 IEEE 17th International Symposium on A World of Wireless, Mobile and Multimedia Networks (WoWMoM), Coimbra, 2016, pp. 1-9, doi: 10.1109/WoWMoM.2016.7523548.
- [154] J. Wang, W. Cheng and H. Zhang, "Caching and D2D assisted wireless emergency communications networks with statistical QoS provisioning," in *Journal of Communications and Information Networks*, vol. 5, no. 3, pp. 282-293, Sept. 2020, doi: 10.23919/JCIN.2020.9200891.

- [155] S. Abdellatif, O. Tibermacine, W. Bechkit and A. Bachir, "Service Oriented D2D Efficient Communication for Post-Disaster Management," 2020 International Wireless Communications and Mobile Computing (IWCMC), Limassol, Cyprus, 2020, pp. 970-975, doi: 10.1109/IWCMC48107.2020.9148538.
- [156] X. Liu et al., "UAV Coverage for Downlink in Disasters: Precoding and Multi-hop D2D," 2018 IEEE/CIC International Conference on Communications in China (ICCC), Beijing, China, 2018, pp. 341-346, doi: 10.1109/ICCCChina.2018.8641260.
- [157] C. Wei, "A SINR-Based Synchronization Protocol for D2D Communications in Public Safety," in *IEEE Access*, vol. 7, pp. 15113-15124, 2019, doi: 10.1109/ACCESS.2019.2893629.
- [158] K. Ali, H. X. Nguyen, Q. Vien, P. Shah and Z. Chu, "Disaster Management Using D2D Communication With Power Transfer and Clustering Techniques," in *IEEE Access*, vol. 6, pp. 14643-14654, 2018, doi: 10.1109/ACCESS.2018.2793532.
- [159] Z. Chu et al., "D2D cooperative communications for disaster management," 2017 24th International Conference on Telecommunications (ICT), Limassol, 2017, pp. 1-5, doi: 10.1109/ICT.2017.7998227.
- [160] G. Huang, J. Hu, S. Pan, Y. Zhang, H. Han and G. Zhang, "D2D relaying based multicast service in Public Safety Networks," 2016 35th Chinese Control Conference (CCC), Chengdu, 2016, pp. 6923-6927, doi: 10.1109/ChiCC.2016.7554448.
- [161] J. S. Kim, J. Gu, M. Y. Chung and J. S. Hong, "A novel medium access scheme for cluster based Device-to-Device broadcast communications," 2015 International Conference on Information Networking (ICOIN), Cambodia, 2015, pp. 397-401, doi: 10.1109/ICOIN.2015.7057925.
- [162] A. Sofwan, "Performance analysis of MAC protocol for resource sharing D2D and M2M in unlicensed channel," 2016 3rd International Conference on Information Technology, Computer, and Electrical Engineering (ICI-TACEE), Semarang, 2016, pp. 397-402, doi: 10.1109/ICI-TACEE.2016.7892479.
- [163] S. N. Swain, R. Thakur and S. R. M. Chebiyyam, "Coverage and Rate Analysis for Facilitating Machine-to-Machine Communication in LTE-A Networks Using Device-to-Device Communication," in *IEEE Transactions on Mobile Computing*, vol. 16, no. 11, pp. 3014-3027, 1 Nov. 2017, doi: 10.1109/TMC.2017.2684162.
- [164] S. Hamdoun, A. Rachedi, H. Tembine and Y. Ghamri-Doudane, "Efficient transmission strategy selection algorithm for M2M communications: An evolutionary game approach," 2016 IEEE 15th International Symposium on Network Computing and Applications (NCA), Cambridge, MA, 2016, pp. 286-293, doi: 10.1109/NCA.2016.7778632.
- [165] J. Shang, L. Gui, H. Zhou, M. Dong and J. Chen, "A group-based M2M multiple access scheme in massive MIMO MU-SCMA cellular networks," 2016 8th International Conference on Wireless Communications & Signal Processing (WCSP), Yangzhou, 2016, pp. 1-6, doi: 10.1109/WCSP.2016.7752657.
- [166] B. Panigrahi, H. K. Rath, R. Ramamohan and A. Simha, "Energy and spectral efficient direct Machine-to-Machine (M2M) communication for cellular Internet of Things (IoT) networks," 2016 International Conference on Internet of Things and Applications (IOTA), Pune, 2016, pp. 337-342, doi: 10.1109/IOTA.2016.7562748.
- [167] S. Hamdoun, A. Rachedi and Y. Ghamri-Doudane, "Radio Resource Sharing for MTC in LTE-A: An Interference-Aware Bipartite Graph Approach," 2015 IEEE Global Communications Conference (GLOBECOM), San Diego, CA, 2015, pp. 1-7, doi: 10.1109/GLOBECOM.2015.7417719.
- [168] G. Rigazzi, N. K. Pratas, P. Popovski and R. Fantacci, "Aggregation and trunking of M2M traffic via D2D connections," 2015 IEEE International Conference on Communications (ICC), London, 2015, pp. 2973-2978, doi: 10.1109/ICC.2015.7248779.
- [169] G. Rigazzi, F. Chiti, R. Fantacci and C. Carlini, "Multi-hop D2D networking and resource management scheme for M2M communications over LTE-A systems," 2014 International Wireless Communications and Mobile Computing Conference (IWCMC), Nicosia, 2014, pp. 973-978, doi: 10.1109/IWCMC.2014.6906487.
- [170] M. Haus, M. Waqas, A. Y. Ding, Y. Li, S. Tarkoma and J. Ott, "Security and Privacy in Device-to-Device (D2D) Communication: A Review," in *IEEE Communications Surveys & Tutorials*, vol. 19, no. 2, pp. 1054-1079, Secondquarter 2017, doi: 10.1109/COMST.2017.2649687.
- [171] R. T. V and K. M, "A Survey on Device to Device Communications," 2022 International Conference for Advancement in Technology (ICONAT), 2022, pp. 1-6, doi: 10.1109/ICONAT53423.2022.9725869.
- [172] Malik, P.K., Wadhwa, D.S. and Khinda, J.S. A Survey of Device to Device and Cooperative Communication for the Future Cellular Networks. *Int J Wireless Inf Networks* 27, 411-432 (2020). <https://doi.org/10.1007/s10776-020-00482-8>