

Flexible Multicarrier PHY Design for Cognitive Radio in White Space

R. Datta¹, M. Gautier², V. Berg², Y. Futatsugi³, M. Ariyoshi³, M. Schühler⁴,
Zs. Kollár⁵, P. Horváth⁵, D. Noguet² and G. Fettweis¹

¹Vodafone Chair Mobile Communications Systems, TU Dresden, Germany

²CEA, LETI, Minatec, Grenoble, France

³System Platforms Research Laboratories, NEC Corporation, Japan

⁴Fraunhofer Institute for Integrated Circuits IIS, Erlangen, Germany

⁵Budapest University of Technology and Economics, Budapest, Hungary

Email: rohit.datta@ifn.et.tu-dresden.de

Abstract— Opportunistic use of White Spaces (WS) has opened up a whole new paradigm in research on cognitive radio (CR). One of the issues addressed by the QoS MOS project is the design of a flexible and efficient physical layer (PHY) for CR systems. To this aim, different modulation techniques are being investigated and are presented in this paper. They fulfill the low out of band leakage and spectral efficiency requirements of a CR operating in fragmented WS. The design of reconfigurable and flexible radio-frequency (RF) front-end is also introduced, since its performance is tightly linked to these parameters and to the implementation feasibility and constraints. Emphasis is put on benchmarking the performance of the proposed schemes over classical approaches.

Keywords - Cognitive Radio, White Space, PHY design, spectral efficiency, interference avoidance, filter bank, RF design.

I. INTRODUCTION

Recent regulations allowing opportunistic use of WS in licensed frequency bands has inspired numerous research activities on CR [1]. The European FP7 QoS MOS project [2] proposes to develop a framework for Quality of Service (QoS) and mobility driven CR systems in the WS.

One key challenge for the opportunistic radio communication is the design of flexible PHY. QoS MOS aims at designing a robust PHY adapted to a heavily fragmented spectrum: the envisaged transmitted waveform should achieve high spectrum efficiency while meeting the constraints of a flexible RF architecture.

OFDM is the initial choice for any multicarrier systems, but causes strong spectral leakage. In order to fulfill QoS MOS requirements, where incumbent signals are not to be interfered with, innovative multicarrier modulation techniques should be proposed as alternative solutions for CR PHY design.

To improve spectrum efficiency, three modulation techniques are considered in QoS MOS: the Filter Bank Multi Carrier (FBMC) concept [3], the innovative Interference Avoidance transmission by Partitioned Frequency Time domain (IA-PFT) and the Generalized Frequency Division Multiplexing (GFDM) [4], with a reduced Cyclic Prefix. They aim at achieving low adjacent leakage spectrum, thereby inducing higher spectral efficiency. These techniques appear to be good candidates for CR PHY. Further requirements and

performance parameters are analyzed and supported by simulations in the paper.

The other aspect addressed in this paper is that an efficient CR system requires spectrum aggregation capability and demands flexible RF architectures which complement the sophisticated baseband processing.

The remainder of the paper is organized as follows: Sections II, III and IV detail the three PHY techniques under investigation in QoS MOS: FBMC, IA-PFT and GFDM respectively. Section V considers the design of a reconfigurable RF front-end and is followed by the concluding section.

II. FBMC PHYSICAL LAYER

In recent CR literature, filter bank based signal processing has been recognized as a high performance technique particularly well-suited for the opportunistic user transceiver [5]. The QoS MOS project is proposing a real-time validation of a CR system based on FBMC. For this purpose, a hardware testbed is being developed.

In this section, FBMC modulation is introduced and spectral efficiency gains are computed for different study cases.

The FBMC structure is described in Fig. 1. A transmultiplexer is the core of the system [3]. The synthesis filter bank consists of all parallel transmit filters and the analysis filter bank includes the matching receive filters.

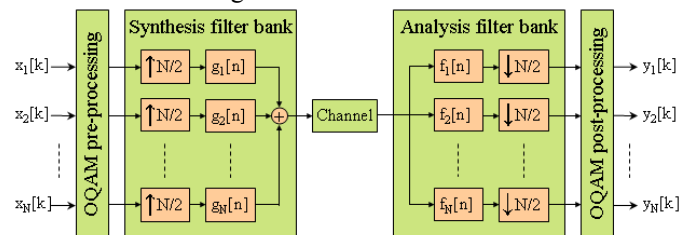

Figure 1. Structure of the FBMC modulation and demodulation.

The distinctive feature of the FBMC technique is its ability to provide improved frequency selectivity through spectrally well-shaped prototype filters at the cost of a longer impulse response. Due to the frequency selectivity of the channel, FBMC only requires orthogonality for the neighboring sub-channels and offset quadrature amplitude modulation

(OQAM) is used for this purpose [3]. The combination of filter bank with OQAM modulation guarantees the orthogonality without the need of a CP as opposed to OFDM. Thus, the data rate loss induced by CP is avoided.

In comparison to OFDM architectures, FBMC introduces a complexity overhead that is not negligible. It is therefore essential to understand the spectral efficiency gain provided by FBMC techniques in comparison to OFDM. We propose to illustrate the potential spectral gain by using a practical approach based on two examples inspired by widely deployed standards: DVB-T [6] and IEEE 802.11a/g [7]. In both examples, the gain in terms of number of frequency carriers will be first estimated assuming the spectrum mask recommended in the standard. This gain will be called the frequency gain. The gain coming from the absence of CP will then be estimated and will be called time gain. Both gains will be added to estimate the overall spectral efficiency gain.

In the example of DVB-T, we considered the mode used in France (FFT size 8k, CP 1/32). Using the same spectrum mask, an FBMC may send 7497 active carriers instead of the 6817 recommended in the standard giving a frequency gain of almost 10%. The frequency gain is also estimated in the study case of IEEE 802.11a/g (FFT size 64, CP 1/4) and depicted in Fig. 2. The number of active carriers may increase from 52 to 54, giving a frequency gain of 3.8%. The first side lobe is attenuated by at least 45 dB for FBMC with the filter structure proposed in [5].

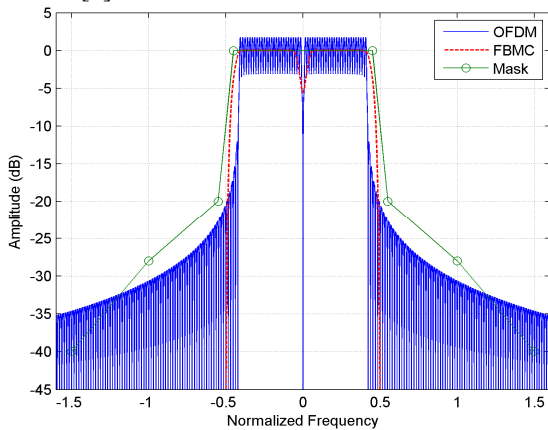

Figure 2. Power spectral density comparison in IEEE 802.11a/g.

In order to estimate the time gain, we assume that FBMC with adequate equalization provides at least as good performance as OFDM [8] (equalization issue is discussed at the end of the section). The gain comes then directly from the absence of CP in the case of DVB-T, i.e. a gain of 3%. In the case of burst communications such as IEEE 802.11a/g, the gain is slightly less straightforward to estimate. The rising time introduced by the prototype filter should be considered as well. Special attention should be paid to the preamble [7]. For FBMC, burst synchronization requires some silent symbols in the preamble in order to prevent the first data symbols to interfere with the preamble. Thus, in order to compare FBMC with OFDM in the case of IEEE 802.11a/g, we propose to use the following durations for the preambles: 4 symbols for OFDM and 12

symbols for FBMC. As in the example of DVB-T, the gain from the absence of CP is also taken into account.

In IEEE 802.11a/g, burst duration may vary between 1 and 152 OFDM symbols. For the average burst duration of 76, it is possible to send 12 extra data symbols during the same time using the FBMC waveform or a time gain of 15.8%. The results are summarized in Table I.

TABLE I. RELATIVE SPECTRAL EFFICIENCY GAIN.

Standard	Spectral Efficiency Gain relative to OFDM		
	Frequency Domain	Time Domain	Total Gain
DVB-T	10 %	3 %	13 %
IEEE 802.11a/g	3.8 %	15.8 %	19.6 %

FBMC has shown strong spectral efficiency performance. The results should further favor FBMC for applications where out of band radiation power levels are critical. This is particularly the case of CR communication systems.

Due to multipath propagation, equalization has to be performed. In conventional multicarrier systems the most common technique is the CP based approach because of its robustness and simplicity. The use of the CP mitigates the Inter-Symbol Interference (ISI) as long as the CP is longer than the channel delay spread. Only linear distortions will appear during equalization, which can be compensated by a phase and amplitude correction.

The absence of a CP in FBMC inevitably leads to ISI which causes an error floor to appear for high SNR regimes. Several approaches have been proposed for the equalization of FBMC systems such as in [9]. These methods are based on a per subcarrier MMSE equalization. Simulation results are shown in Fig. 3. It can be seen that for the AWGN channel the FBMC system outperforms the OFDM system with CP. The Bit Error Rate (BER) values for FBMC over multipath channels using equalization for SNR values lower than 20 dB are still slightly better. On the other hand, when reaching higher SNR values, the FBMC system exhibits an error floor due to the residual ISI, regardless of the chosen equalization technique. This phenomenon will be mitigated when error correction coding is applied.

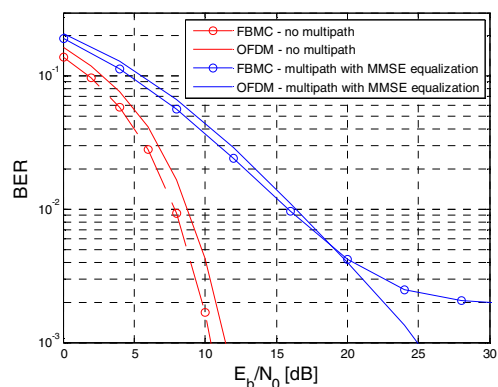

Figure 3. BER versus E_b/N_0 for the FBMC and OFDM MMSE equalization schemes over AWGN and multipath channels.

To enable better detection, an iterative decision feedback equalization technique was also proposed [10], but eventually this scheme also reaches an error floor. This relatively low error floor can be mitigated by appropriate coding. Hence, FBMC is a viable alternative to OFDM demanding moderate complexity increase in the equalizer.

III. INTERFERENCE AVOIDANCE TRANSMISSION BY IA-PFT

Aiming at reducing the undesired spectrum emission caused by the opportunistic system, the new method IA-PFT is proposed. The following sub-sections present an overview and fundamental performances of IA-PFT.

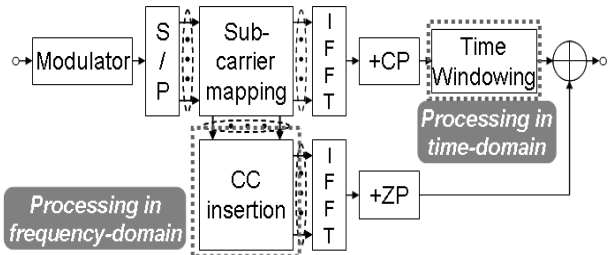

Figure 4. IA-PFT transmitter structure.

A. IA-PFT Transmitter Structure

IA-PFT structure features a parallel combination scheme of Time Windowing (TW) [7] and Cancellation Carrier (CC) [11][12] as shown in Fig. 4. The transmitted bit stream is modulated and divided into a signal group to be processed by TW and a signal group to be processed by CC at the subcarrier mapping block. TW processed signal group is converted by IFFT. Then, a CP is appended to the head of the OFDM symbols. After appending CP, signal shaping in time-domain is carried out at the TW block. On the other hand, CC processed signal group is fed to CC insertion block. At CC insertion block, CC vector is inserted to CC processed signal group in frequency-domain to suppress the undesired spectrum emission in interference avoidance band. After converting by IFFT, a Zero-Padding (ZP) guard interval is appended to the head of the OFDM symbols. Finally, TW processed signal group and CC processed signal group are multiplexed.

B. Interference Suppression Performance

Fig. 5 shows a comparison example of transmission spectrum of the interference avoidance transmission techniques, where the major parameters listed in Table II is assumed. The number of interference avoidance band (N_i) is equivalent to 32 turned off sub-carriers. IA-PFT is applied to each spectrum edge (two CC at each spectrum edge). According to the simulation result, TW alone cannot achieve the high suppression gain near the transmission subcarriers in the interference avoidance band. Meanwhile, CC alone cannot achieve the high suppression gain near the centre of the interference avoidance band. For IA-PFT, the maximum suppression gains of power spectrum density are respectively 6 dB and 12 dB better than those of CC and TW.

Fig. 6 shows the power spectrum density of IA-PFT when a parameter Q is changed. The parameter Q represents the number of subcarriers being processed by CC insertion block per spectrum edge. In other words, the allocation ratio between TW processed signal and CC processed signal can be

determined by Q . As seen from the evaluation results in Fig. 6, if Q is set to a small value, the power spectrum density of IA-PFT approaches that of TW. If Q is set to a large value, the power spectrum density of IA-PFT approaches that of CC.

TABLE II. SIMULATION PARAMETERS.

Parameter	Assumption
FFT size	1024
Maximum number of subcarriers	600
CP (ZP) sample	72
Subcarrier spacing	15 kHz
Modulation	QPSK

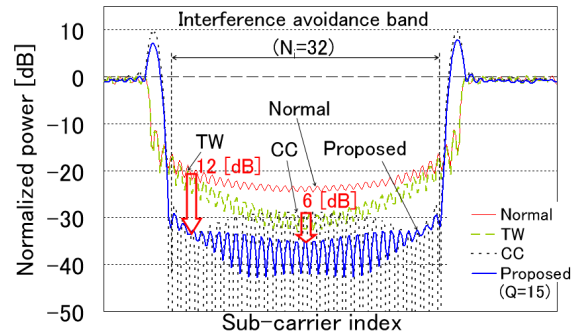

Figure 5. Power spectrum density of IA-PFT.

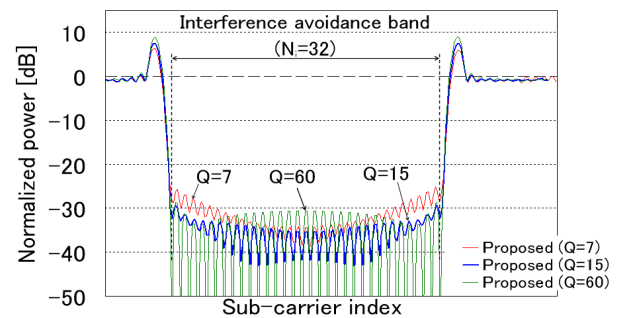

Figure 6. Power spectrum density of IA-PFT with variable Q .

C. Evaluation of PAPR

Fig. 7 shows Peak to Average Power Ratio (PAPR) of IA-PFT transmission signals. In this evaluation, the simulation parameters were set to the same values as in Fig. 5.

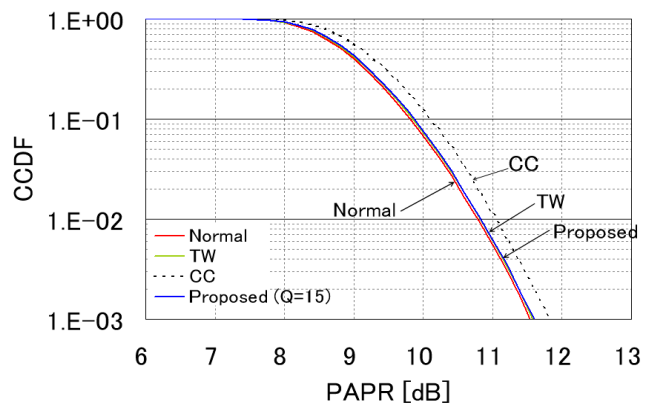

Figure 7. PAPR performance of IA-PFT.

According to the simulation result, PAPR of CC is increased by 0.3 dB compared to a normal OFDM when Complementary Cumulative Distribution Function (CCDF) is equivalent to 1%. It can be seen that the increase of PAPR for CC is caused by ZP used for all the subcarriers instead of CP. On the other hand, PAPR of IA-PFT is almost same as that of the normal OFDM since ZP is partially used for the subcarriers.

It is therefore concluded that IA-PFT is a promising candidate for QoS MOS transmitter. It is also noted that typical OFDM receivers can be applied for IA-PFT.

IV. GFDM: GENERAL FREQUENCY DIVISION MULTIPLEX

GFDM [4] is a new multicarrier modulation technique which is particularly suitable for cognitive PHY in fragmented white spaces. Not being restricted to rectangular pulse, as in OFDM, here in GFDM, the choice of suitable Nyquist pulse shape restricts the out of band radiation of the opportunistic signals to interfere with the incumbent.

As described in [4], GFDM is a multicarrier system incorporating a tail-biting technique. The transmit signal block has a CP accounting for the Tx/Rx filtering and the mobile channel. The CP is shortened by dropping the Tx/Rx filter part [13] and then the tail of the payload is added onto the CP to emulate circular convolution. In the transmitter part of the system, as shown in Fig. 8, the binary data is QAM modulated and then the transmit pulse shaping filter shapes the modulated data, to improve spectral efficiency. Then after up-conversion the transmitter transmits the modulated signals with CP.

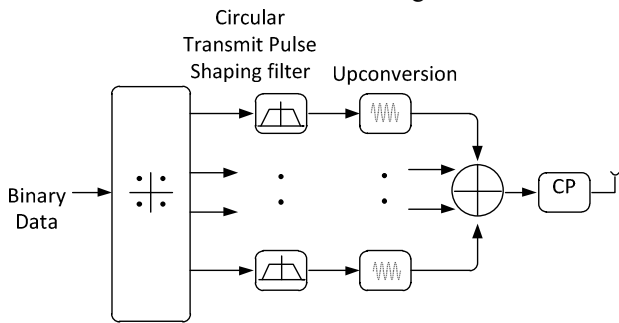

Figure 8. GFDM transmit system model.

In the receiver part of the system, as shown in Fig. 9, the CP is removed and then after equalization, down conversion is performed. The received signal is then passed through the matched received pulse shaping filter, followed by a sampler and a detector to get back the binary data.

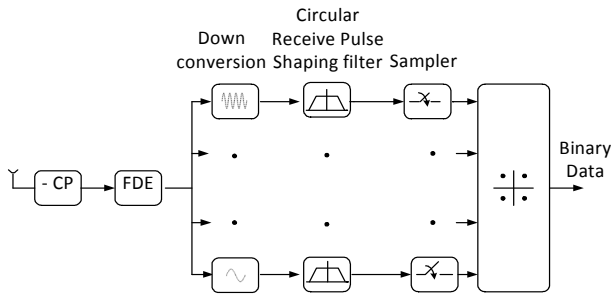

Figure 9. GFDM receive system model.

As shown in [4][13], the PAPR of this system is better than that of OFDM by about 1 dB at 1% CCDF; as here we have less number of subcarriers compared to OFDM. The tail-biting technique, even though increases the throughput of the system, causes Inter-Carrier Interference (ICI) between two adjacent subcarriers, not only at the same time instant, but also with symbols with different time stamp. Because of non-orthogonality of the subcarriers, ICI is very pronounced and, as shown in Fig. 10, the BER curve of GFDM is a bit degraded compared to theoretical AWGN BER curve [13] using a one-tap equalization. As in FBMC system, GFDM could achieve good performance, demanding reasonable complexity increase in the equalizer.

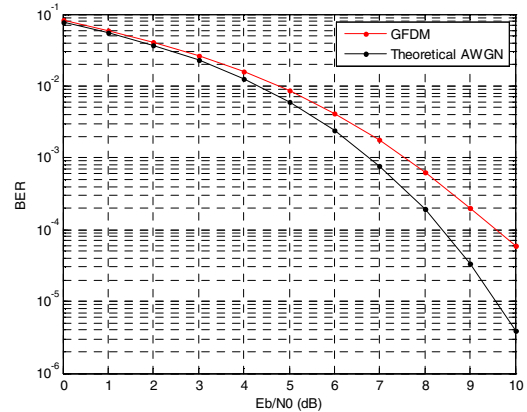

Figure 10. BER performance of GFDM vs theoretical AWGN BER.

GFDM shows a lot of potential for being adopted as a multicarrier modulation technique in CR PHY design. The choice of pulse shaping techniques makes the spectral mask highly efficient and hence is a suitable candidate for adaptation in QoS MOS PHY design.

V. RECONFIGURABLE RF TRANSCEIVER FRONT-END

Keeping with the intentions of a CR system, the hardware architecture is supposed to be highly flexible. The signal processing should therefore be moved to the digital domain as far as possible, minimizing the effort and the costs of the analogue hardware section. Following this line, a direct-sampling approach, i.e., converting the RF signal directly from or to the digital domain would be best suited. In consideration of the frequency bands possibly covered by a CR system, this is difficult to implement, as appropriate high-performance analogue-to-digital converters (ADC) and digital-to-analogue converters (DAC) are required. In QoS MOS, another approach is therefore applied using for each frequency band of interest a single down-conversion and up-conversion stage, respectively, to relax the requirements on the digital hardware components.

A schematic view of a possible RF receiver front-end is portrayed in Fig. 11. The RF signal received by the antenna is amplified and then directed by a multiplexer (switch) to the signal path covering the frequency range, where the signal is expected. Following a tunable pre-selection filter, the signal is down-converted to a fixed intermediate frequency (IF) and directed to an anti-aliasing filter (AAF) by a second multiplexer, before the AD conversion takes place. For the RF transmitter front-end, a setup complementary to the receiver

section shown in Fig. 11 can be implemented, consisting of a DAC, an AAF, an up-converter followed by a tunable band-pass filter, and a power amplifier. Depending on the IF chosen, the RF front-end architecture as illustrated in Fig. 11 may serve as low-IF or zero-IF receiver, provided that in-phase-quadrature (IQ) down-converters are applied. Both approaches, however, suffer from serious drawbacks, particularly for the transmitting section [14], such as DC offsets, IQ imbalances, and injection locking.

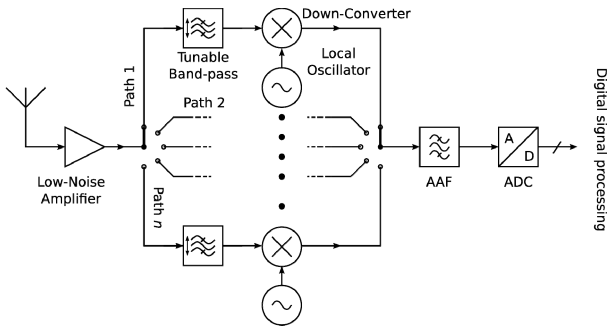

Figure 11. Architecture of the multi-band RF receiver front-end.

One objective considered in QoSMMOS is the aggregation of spectral regions, i.e., to use distinct frequency channels simultaneously. To be able to apply this technique over frequency regions extending the bandwidth of the IF filter, the architecture shown in Fig. 11 has to be modified. Fig. 12 illustrates how. The block diagram shows two *identical* signal paths, each comprising of an amplifier, a tunable band-pass filter, and a down-converter. After distributing the incoming signal to both paths by a broadband power splitter, part of the signal is selected and converted down at one path, the remaining part of the signal is processed by the other one. The frequencies of the local oscillators have to be chosen such that all spectral parts of the signal fit into the IF band. The amplifiers provide a decoupling between both paths necessary due to the alternating input impedance of the band-pass filters.

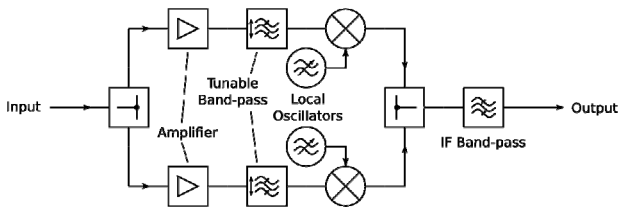

Figure 12. Frequency selection and conversion for spectrum aggregation.

The proposed RF front-end architecture will be implemented and experimentally evaluated in course of QoSMMOS, figuring out the main challenges, which come along with the requirements on a CR system.

VI. CONCLUSION

This paper describes QoSMMOS investigations on PHY for CR communication. While OFDM is widely used in many standards, this modulation has many drawbacks in heavily

fragmented white space cognitive radio environments. Low spectral leakage can be achieved by adopting FBMC and other innovative PHY designs like GFDM or IA-PFT. Original RF architectures complete the study by addressing multi-band and aggregated spectrum access.

Future works will demonstrate the benefits of advanced PHY in an experimental testbed. One of the proposed solutions will operate in a RF and baseband integrated platform. The testbed will take part of a global QoSMMOS experiment including spectrum management, PHY and realistic radio environment.

ACKNOWLEDGMENT

The research leading to these results was derived from the European Community's Seventh Framework Program (FP7) under Grant Agreement number 248454 (QoSMMOS).

REFERENCES

- [1] J. Mitola, "Cognitive radio: an integrated agent architecture for software defined radio", Ph.D. thesis, Royal Institute of Technology, Stockholm, Sweden, May 2000.
- [2] QoSMMOS project website. available at: <http://www.ict-qosmos.eu>
- [3] P. Siohan, C. Siclet and N. Lacaille, "Analysis and design of OFDM/OQAM systems based on filterbank theory", *IEEE Transactions on Signal Processing*, vol.50, no.5, pp.1170-1183, May 2002.
- [4] G. Fettweis, M. Krondorf and S. Bittner, "GFDM – General Frequency Division Multiplexing", in *Proceedings of IEEE 69th Vehicular Technology Conference (VTC Spring'09)*, 26-29 April 2009.
- [5] H. Zhang, D. Le Ruyet and M. Terre, "Spectral Efficiency Analysis in OFDM and OFDM/OQAM Based Cognitive Radio Networks", in *Proceedings of IEEE 69th Vehicular Technology Conference (VTC Spring'09)*, 26-29 April 2009.
- [6] ETSI EN 300 744 V1.6.1 (2009-01). Digital Video Broadcasting (DVB), Framing Structure, Channel Coding and Modulation for Digital Terrestrial Television. European Standard ETSI, 2009.
- [7] IEEE, "Supplement to IEEE Standard for Information technology—Telecommunications and information exchange between systems—Local and metropolitan area networks—Specific requirements—Part 11: Wireless LAN Medium Access Control (MAC) and Physical Layer (PHY) specifications: High-speed Physical Layer in the 5 GHz Band," IEEE Std 802.11a-1999.
- [8] A. Ikhlef and J. Louveaux, "An enhanced MMSE per subchannel equalizer for highly frequency selective channels for FBMC/OQAM systems", in *Proceedings of IEEE Signal Processing Advances in Wireless Communications (SPAWC'09)*, June 2009.
- [9] T. Ihalainen, T. H. Stütz, and M. Renfors, "Efficient per-carrier channel equalizer for filter bank based multicarrier systems", in *Proceedings of IEEE International Symposium on Circuits and Systems (ISCAS '05)*, May 2005, pp. 3175–3178.
- [10] Zs. Kollár, G. Péceli and P. Horváth, "Iterative decision feedback equalization for FBMC systems", in *Proceedings of IEEE First International Conference on Advances in Cognitive Radio, (COCORA 2011)*, April 2011.
- [11] H. Yamaguchi, "Active interference cancellation technique for MB-OFDM cognitive radio", *Microwave conference 2004*, pp.1105–1108, Oct. 2004.
- [12] S. Brandes, I. Cosovic and M. Schnell, "Sidelobe suppression in OFDM systems by insertion of cancellation carriers", *VTC2005-Fall*, pp.152–156, Sept. 2005.
- [13] N. Michailow, M. Lentmaier, P. Rost and G. Fettweis, "Integration of a GFDM Secondary System in an OFDM Primary System", accepted for publication in *FuNeMs 2011*, Warsaw, Poland.
- [14] B. Razavi, "RF transmitter architectures and circuits", in *Proceedings of the IEEE 1999 Custom Integrated Circuits*, San Diego, CA, May 16-19, 1999, pp. 197-204.