

Newspaper Vending Machine

M Irmansyah¹, E Madona²

Electro, Politeknik Negeri Padang
Campus Politeknik Negeri Padang Limau Manis, Padang, West Sumatra, Indonesia^{1,2}

{irmansyah38@gmail.com¹, emadona38@gmail.com²}

Abstract. A newspaper vending machine is an automatic machine for selling newspapers and customers operate it by themselves. The advantages of vending machine method are meet the concept selling anywhere, closer to customer and cost down in sales. This vending machine uses some coins or money to initiate selling process. The aim of this research is to applied microcontroller to control newspaper vending machine, Programmable Logic Device (PLD) to count coins, light sensor to detect the coin, sensor TCS3200 is used to detect color of money, dc motor to eject newspaper from vending machine and LCD show instruction to purchase the newspaper. The type of microcontroller in this vending machine is ARDUINO ATMEGA328, PLD IC is GAL 22V10. The coin using Rp 1000 and money using Rp 5.000. The newspaper inside the machine is daily newspaper area with the price is Rp 5.000. It means the buyer can buy the newspaper using 5 pieces of coin Rp 1000 or money Rp 5.000. Photodiode and infrared sensors can be used to detect coin. Motor to eject newspaper activated if the amount of coin inserted the machine is 5 coin of Rp 1000. Technology Programmable Logic Device (PLD) can apply as decoder binary to decimal with seven segment displays to count coin for 5 coins. The value of RGB for money Rp 5.000 is read from 4 sides. RGB value of color for the image "tokoh" has range 20<R>14, 20<G>20, 2016. RGB value of color for the image "garuda" has range 10<R>8, 8<G>10, 712. RGB value of color for the image "tenun" has range 11<R>14, 10<G>14, 1410. RGB value of color for the image "Rp 5000" has range 10<R>8, 11<G>8, 87. DC motor to push will active if RGB value Rp 5000 is detected and suitable with RGB designed. The guide of using newspaper vending machine to customer is shown to customers trough LCD and will show "VENDING MACHINE 1 KORAN 5000 ATAU 5 BUAH KOIN 1000".

Keywords: Newspaper, Vending machine, Programmable Logic Device, Microcontroller, Coin, Money, LCD

1 Introduction

Newspaper is a soft publishing and easy discharge, which printed on low-cost paper called newsprint, contains the latest news on various topics. A vending machine is a machine that can provide items such as snacks, soft drinks example soda, alcohol, cigarette, newspapers, lottery ticket, consumer products, and even gold and jewels to customer automatically. Like the original seller, this machine will eject the stuff that we want after we pay for it by inserting some coins or money. The advantages of vending machine method are meet the concept selling anywhere, closer to customer, cost down in sales. For example, vending machine does not need to be

guarded, just left in place. Because it is not guarded, the cost of seller automatically not need anymore. This machine will *24 hours 7 days open* and serve the customer continuously. Another advantage is common products can be consumed by all age usually using coin or money [1], [2], [3], [4].

Programmable Logic Devices (PLD) technology is a digital logic integrated circuit (IC) that can be changed the function using programming. Using PLD technology user can make own design and model that they want and need. It also can be reprogrammed and reconfigure the designing as user needed. The base concept of Programmable Logic Device (PLD) is how to construct a programmable combinational logic circuit. The combinational circuit is a circuit without memory device inside the system. The ability of PLD programming is planned at hardware level. Hardware Description Language (HDL) is a high-level programming language used to program a digital IC. It consists of a number of gates that can be programmed by disconnecting fuse inside the IC. Such as a programming language, HDL has its own rules in hierarchies or systematic programs until the syntax used. HDL technology is classified by the number of existing gates. A programming language used is Warp 4.2 from Cypress. This software will produce a file with extension *.jed and can be downloaded to IC using IC programmers such as the All - 07, Easy Pro and others. Programming by using WARP 4.2 must obey the rules of programming that have been set by the vendor. Although programming language comes from the different vendors but relatively the same because they use the reference to the international standard IEEE. A general description of HDL programming technique can be seen in following explanation. Using Personal Computer (PC), program logic or state diagram can be made by HDL using software text editor. HDL is compiled using software to make the logic circuit detail and produce the output of design that has been done. The circuit operation is simulated in NOVA checked the output of program suitable with user needed. An example of integrated circuit (IC) with PLD technology is GAL22V10 [5]. The figure 1 show chip of IC GAL 22V10:



Figure 1: Chip GAL 22V10

Arduino Uno is aboard base on ATmega 328. This board has 14 pins of digital input/output (6 pins for output PWM), 6 pins input analog, 16 MHz cristal oscillator, USB connection, electrical jack and reset button. All pins contain everything needed to support microcontroller. It just connected to computer using USB or supply from adaptor 7-12 DC or battery to operate it.

TCS3200 is an IC that converts color of light to frequency. The output of this color sensor is frequency which is affected by detection color, influence of light from outside and distance between sensor and the color position that detected will determine level sensor data readout precision, so the sensor should in the dark environment for the maximal result to color reading process. The output sensor also influences by input voltage, so the voltage input must be constant at level +5 VDC. Color sensor module TCS3200 used chip TAOS TCS3200 RGB. This module has been integrated with 4 LEDs. Color sensor module TCS3200 can detect and measure the color intensity. Chip TCS3200 has some photodetectors with color filters for red, green, blue

and clear. These filters' output will be distributed to array for each color. The module has oscillator to produce square pulse which has same frequency with the color detected[6].

The aim of this research is to applied microcontroller Arduino Uno is aboard base on ATmega328 as newspaper vending machine controller, Programmable Logic Device (PLD) using IC GAL22V10 to count coin, light sensor to detect the coin, sensor TCS3200 is used to detect color of money, dc motor to eject to newspaper from vending machine and LCD show you how to purchase the newspaper. The benefits of this research are help people to get newspapers easily when they are on the street, school, office, airport, train station, port, and shopping center.

2 Research Method

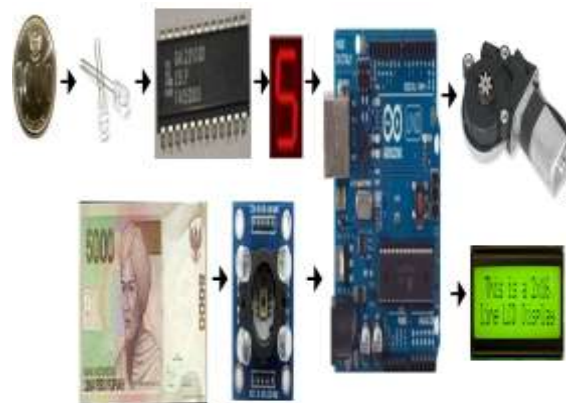

Figure 2: Block diagram of the system

Figure 2 shows the block diagram of vending machine system which can be explained as follow:

1. Coins detector. The function of the coin detector circuit in figure.3 to detect every coin inserted to the machine. When the coin does not pass through the sensor, sensor will provide a logic 0 and sensor provide logic 1 while the coin pass the sensor.

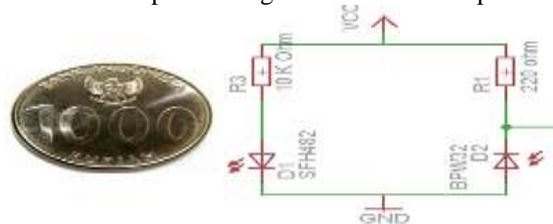

Figure 3: Coin detector circuit

2. Coin counter circuit. This circuit counts the coin inserted into the machine. While coin pass the sensor, this part will count each coin from 1 to 5 and amount of coin will be displayed to seven segments. This circuit will release binary data from each decimal number from 1 to 5. The binary data will be sent to microcontroller. Coin counter circuit using technology Programmable logic device (PLD). This technology makes the design

of IC 7448, decoder binary to decimal, for seven segment applications using IC GAL 22V10.

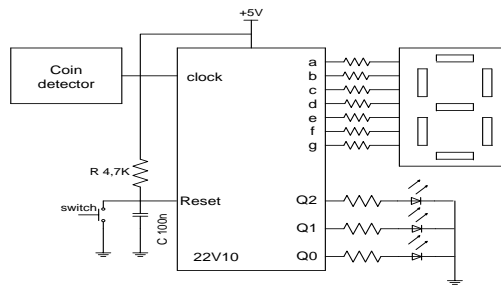

Figure 4: Coin counter circuit

Figure 4 shows the design of hardware from decoder binary to decimal consist of :
 Infrared and photodiode as a coin detector
 Reset to restore the system to original condition
 LED as an output binary indicator
 Seven segments to show the decimal number.

- Part of the money detector
 The color sensor is used to detect money in Rp 5.000 value. If this money has been detected by color sensor then solenoid will be pinning the money and DC motor will withdraw the money. Testing of Rp 5.000 money detector using color sensor TCS3200.



Figure 6: Money detector using a color sensor TCS3200

- Figure 5 shows a newspaper vending machine controller circuit. This part using microcontroller Arduino UNO as controller of all the existing sections in the newspaper vending machine system.



Figure 5: Microcontroller Arduino UNO

- Newspaper ejection part. In this part, motor DC is used to pull up the newspaper out of the machine.
 LCD part. This LCD will show the instruction use the machine to purchase the newspaper

The vending machine working system process requires input using coins and money. Coin or money is inserted into a slot in the machine and fall inside the machine. Then, automatically machine ejects the newspaper which is paid by the buyer. The price of the newspaper is Rp 5.000, it means the buyer can buy the newspaper using 5 pieces of coin Rp 1.000 or money Rp 5.000. LCD will show the instruction to purchase the newspaper.

3 Results And Analysis

3.1 Testing of Coin Detector Circuit and Decoder Binary to Decimal Using Sevensegment Display (Counter) and PLD Technology Using IC GAL 22V10

While each coin passes the coin sensor, it counts from 1 to 5. The result is displayed to seven segment circuits of coin counter using technology *Programmable logic device* (PLD). The measurement of voltage photodiode output circuit not only when received the light but also when no light around infrared. This circuit is designed and built to display decimal numbers from 0 to 5 using seven segment and binary data of this number using LED. The result of decoder binary to decimal program is simulated using NOVA to test the truth of logic result. The result of simulation appropriate with design, next step is downloaded the program to IC GAL 22V10. When no coin is inserted, the output of this circuit is logic 0 and logic 1 while inserted the coin. The output of coin detector circuit in logic 0 and logic 1 will be inputted to circuit of decoder binary to decimal using seven segments as pulse to count coin (counter) which is inserted. The amount of coin which detects this circuit is 5 coins Rp 1.000. NOVA simulation result for decoder binary to decimal with seven segment display and LED (counter) using PLD technology shows in figure 7.

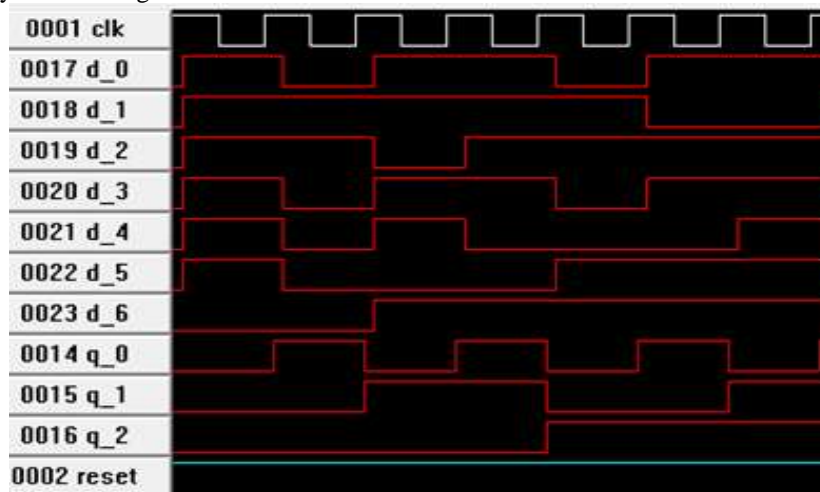

Figure 7: Simulation result of decoder binary to a decimal using seven-segment display

Each coin detects using the coin detector circuit will trigger the counter circuit to count the coin. The output counter will show seven segments and binary output to LED. In table 1, for first coin, display seven segments show numeral 1 and binary "001". Second coin show numeral 2 and binary "010". Numeral 3 and binary "011" for third coin, 4 and binary "100" for fourth coin and the last coin shows numeral 5 and binary "101".

Table 1: Measurement result for photodiode output voltage and seven-segment display





Coin	Biner	Seven Segment Display	Photodiode output voltage when detection coin (volt)	Photodiode output voltage when not detection coin (volt)
1	001		3	0
2	010		3	0
3	011		3	0
4	100		3	0
5	101		3	0

Table 1 can be seen as the result of measurement photodiode output voltage and seven-segment display. The measurement of this circuit to determine the output voltage from photodiode not only when receiving the light but also while not got the light from infrared. The output voltage of coin detector circuit when the photodiode receives light from the infrared is 3V. It caused photodiode receive light form infrared then increase the intensity of light at photodiode. This condition will increase the current in photodiode and its resistance will low and causing the output voltage on the coin detection circuit becomes large.

When a coin is inserted or blocking the light coming into the photodiode then the output voltage of the coin detector circuit measured is 0 V. It is because the photodiode does not receive the light from infrared then there is no intensity of light at the photodiode. This condition decreases the current in photodiode to zero and its resistance will big and causing the output voltage on the coin detection circuit becomes small.

When no coin is inserted, the output of this circuit is logic 0 and logic 1 while inserted the coin. The output of the coin detector circuit in logic 0 and logic 1 will be inputted to circuit of decoder binary to decimal using seven segments as pulse to count coin (counter) inserted. The amount of coin which detects using this circuit is 5 using coin Rp 1000.

3.2 Testing of Rp 5.000 Money Detector Using Color Sensor TCS3200

This system operates base on frequency range which detected by color sensor TCS3200 from the color of money. Light intensity from outside influence the output range of frequency and distance between sensor and money also influence it. The reading of color money frequency suitable with basic color of money, red, green and blue in sequential. Data output is analyzed with arrange the frequency range in the software and the RGB limitation for each value of money. Color sensor output is frequency and in microcontroller the sensor output will comparing with frequency data software to recognize the money to run the function the system. The distance between color sensor and money is 1 centimeter. The process is starting from

photodiode red caught the led light reflection from the money and changed by oscillator to pulse signal. The value of frequency depends on value of light intensity received by photodiode red. The next process for green and blue filters is similar to red filter. If sensor can detect the money, newspaper will trough out from the machine.

The value of RGB for money Rp 5.000 is read from 4 sides. The RGB value of color for the image “tokoh” has range $20 <R> 14$, $20 <G> 20$, $20 16$. RGB value of color for the image “garuda” has range $10 <R> 8$, $8 <G> 10$, $7 12$. The RGB value of color for the image “tenun” has range $11 <R> 14$, $10 <G> 14$, $14 10$. RGB value of color for the image “Rp 5000” has range $10 <R> 8$, $11 <G> 8$, $8 7$. DC motor to push will active if RGB value Rp 5000 is detected and suitable with RGB designed.

3.3 Testing of Machine Guide Utilization Part

Figure 8 shows LCD is used to show how to use the newspaper vending machine to help customer to use the vending machine appropriately. The LCD will show "VENDING MACHINE 1 KORAN 5000 ATAU 5 BUAH KOIN 1000".

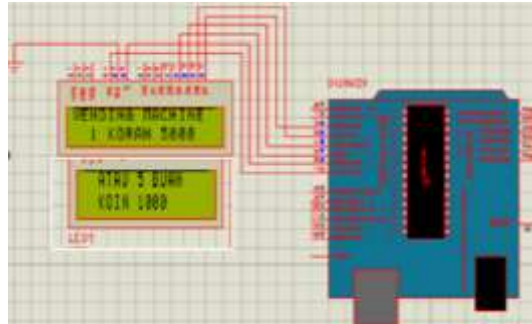

Figure 8: Machine guide utilization

3.4 Testing of Driver Circuit to Newspaper Ejection

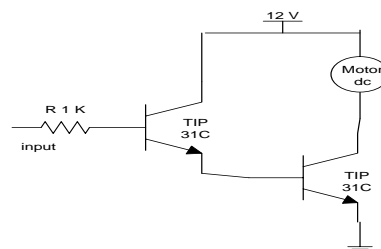

Figure 9: Schematic circuit of the motor driver to newspaper ejection

Darlington circuit in figure 9 is used to activate motor as a newspaper ejection. This circuit operates when the base of transistor gets voltage. If logic 1 is given to the input with level voltage 5 volt, the motor will active and push the newspaper out and the logic of input will be change to logic 0 with level voltage 0 volt and motor will be stopped.

4 Conclusions

Photodiode and infrared sensors can be used to detect coin. While photodiode receives light from infrared, output voltage of photodiode is 3 volt and 0 volt when the light is closed by the coin. Motor to eject newspaper activated if the amount of coin inserted the machine is 5 coin of Rp 1000. Technology Programmable Logic Device (PLD) can apply as decoder binary to decimal with seven segment displays to count coin for 5 coins. The value of RGB for money Rp 5.000 is read from 4 sides. RGB value of color for the image "tokoh" has range 20<R>14, 20<G>20, 2016. RGB value of color for the image "garuda" has range 10<R>8, 8<G>10, 712. RGB value of color for the image "tenun" has range 11<R>14, 10<G>14, 1410. The RGB value of color for the image "Rp 5000" has range 10<R>8, 11<G>8, 87. DC motor to push will active if RGB value Rp 5000 is detected and suitable with RGB designed. The guide of using newspaper vending machine to customer is shown to customers trough LCD and will show "VENDING MACHINE 1 KORAN 5000 ATAU 5 BUAH KOIN 1000".

References

- [1] Alifuddin, "The Design of Vending Machine Development with Rupiah's Currency Change System," STMIK Handayani Makasar Indonesia, 2014.
- [2] D. S. Adiputra, Y. Palapa, and H. Subagiyo, "Mesin Penjual Softdrink Otomatis Berbasis ATMega8535," *J. Elem.*, vol. 1, no. 2, 2015.
- [3] Kamalanathan, "Automatic Paper Vending Machine," *Int. J. Sci.*, vol. 4, no. 4, 2015.
- [4] P. Pradeepa, T. Sudhalavanya, K. Suganthi, N. Suganthi, and M. Menagadevi, "Design and Implementation of vending machine using Verilog HDL," *Int. J. Adv. Eng. Technol.*, vol. 4, pp. 51–53, 2013.
- [5] N. P. Cook, *Practical Digital Electronics*. New Jersey: Prentice Hall, 2004.
- [6] Baskara, "Sensor Warna TCS3200 and TCS3210," *Baskara Blog*, 2013. [Online]. Available: <http://baskarapunya.blogspot.com/2013/05/sensor-warna-tcs3200-and-tcs3210.html>. [Accessed: 14-Jul-2018].