

Comparison of Passive LC and Passive Single Tuned Filters in Reducing Current Harmonics

Azmi Rizki Lubis¹, Muhammad Dani Solihin², Marwan Affandi³, S Sriadhi³

{ rizki.loebiez@gmail.com, danisolihin90@gmail.com, mr1.affandi@gmail.com, sriadhi@unimed.ac.id }

¹Faculty of Engineering, Universitas Islam Sumatera Utara, Medan, Indonesia

²Faculty of Engineering, Universitas Sumatera Utara, Medan, Indonesia

³Faculty of Engineering, Universitas Negeri Medan, Medan, Indonesia

Abstract: Harmonics generated by non-linear loads will cause the current to be in the form of short pulses. From the measurement data conducted, there is a harmonic on Individual Harmonic Distortion (IHDi) fifth order on current transformer that is not compliant with IEEE 519 - 1992 standard. In this study aims to compare the use of passive LC filter with Passive Single-Tuned Filter in reducing harmonics current is simulated using computer program. The simulation results show the Current Individual Harmonic Distortion (IHDi) fifth order in the current transformer is reduced according to IEEE standard 519 - 1992 where IHDi fifth order is reduced to 0.04% using Passive LC Filter and 1.14% using Passive Single-Tuned Filter and THDi decreased to 0.28% using Passive LC Filter and 2.54% using Passive Single-Tuned Filter.

Keywords: Current Transformer, Harmonic, Individual Harmonic Distortion (IHDi), LC Passive Filter, Passive Single-Tuned Filter.

1. Introduction

The used of non-linear loads nowadays in industrial system has increased accordance with the present technology. (Ismail, Anuar et al., 2010). The use of non-linear devices such as rectifiers or converters, power supplies and other devices utilizing solid-state switching has increased in industry during recent years. Harmonics are generated when nonlinear equipment draws current in short pulses. (Henderson and Rose., 1994). The use of semiconductor power converters as power supplies for both AC and DC motors is steadily increasing. (Kennedy and Ivey., 1990). However, the saturation of the current transformer in the operation of the protection device produces different impacts for the type of protection equipment and protection scheme. (Kojovic., 2002). If current transformer (CT) characteristics are not properly selected for fault conditions, saturation will occur and relays can have delayed response or even fail to trip. (Wiszniewski, Rebizant et al., 2008). Basically a current transformer is used for current measurement. The class of accuracy is the main parameter for determining the fault limit and accuracy of the current transformer (Yahyavi, Brojeni et al., 2007).

From the measurements made on PCC (Point of Common Coupling) secondary side current transformer of power transformer contained in PT. Gunung Gahapi Sakti for one week obtained a current THD value of 24.8%. These measurement data have exceeded the standard set by IEEE 519-1992 with the calculation of short circuit ratio.

2. Literature Review

Harmonics is the formation of waves with different frequencies which are the multiplication of integers with the frequency of integers with their fundamental frequency. For

example, the fundamental frequency of a power system is 50 Hz, the second harmonic is a wave with a frequency of 100 Hz and a third harmonic with a frequency of 150 Hz and so on (Arrillaga and Watson., 2004).

2.1 Harmonic Source

Common nonlinear loads that are electronic devices in which there are many components of semiconductors, in the process works as a switch that works on each wave cycle of the voltage source. Electronic equipment in which there are many components of semiconductor or power electronics as a series of electric motor controller (Arrillaga and Watson., 2004).

2.1.1 Standard Harmonics

The harmonic currents injected into the electrical system may have adverse effects on the electrical system equipment, especially on capacitors, transformers, and causing overheating and overloading of motors.

Table 1. THDV limits comply with IEEE 519-1992 standards.

Point Of Common Coupling Voltage	Individual Distortion	Voltage Total Distortion (THDv)	Harmonic Voltage
$V \leq 69KV$	3,0	5,0	
$69KV < V \leq 61KV$	1,5	2,5	
$V > 161KV$	1,0	1,5	

2.1.2 Fourier Series

A periodic function $f(\theta)$ with period 2π that meets the Dirichelet requirements as follows:

1. Has a limited number of discontinuities in a period.
2. Have a limited maximum and minimum in one period.
3. Integral is limited (certain), can be developed into a Fourier series.

The trigonometric series for the periodic function $f(t)$ can be expressed by:

$$f(t) = a_0 + \sum_{n=1}^{\infty} [a_n \cos(n\omega_0 t) + b_n \sin(n\omega_0 t)] \quad (1)$$

Coefficients a_0 , a_n , and b_n can be expressed by :

$$a_0 = \frac{1}{T} \int_0^T f(t) dt \quad (2)$$

$$a_n = \frac{2}{T} \int_0^T f(t) \cos n\omega t dt \quad (3)$$

The fundamental value f for a period is from 0 to T.

$$b_n = \frac{2}{T} \int_0^T f(t) \sin n\omega t dt \quad (4)$$

Where n is harmonic index. Harmonic amplitude can be expressed by :

$$\text{Where } n \geq 1 \quad C_h = \sqrt{a_n^2 + b_n^2} \quad (5)$$

For the value of C as a function n is often depicted in a barchart and is known as "Harmonic Spectrum". The Harmonic spectrum is the distribution of all the amplitudes of the harmonic component as its harmonic order function and is illustrated using a histogram. (Irianto, Sukmawidjaja et al., 2008).

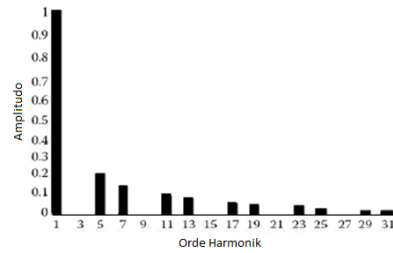

Fig. 1. Harmonic spectrum.

2.1.3 Current Individual Harmonic Distortion (IHD_i)

Current Individual Harmonic Distortion (IHD_i) is the ratio between the RMS values of individual harmonics to the RMS value of the fundamentals. The formula of IHD_i is as follows (Irianto, Sukmawidjaja et al., 2008):

$$IHD_i = \sqrt{\left(\frac{I_h}{I_1}\right)^2} \times 100\% \quad (6)$$

Where :

- IHD_i : Current Individual Harmonic Distortion (%)
- I_h : The current harmonic in order of nth (Ampere)
- I₁ : Fundamental Current (Ampere)

2.1.4 Total Harmonic Distortion

In the electric power system to see Harmonic distortion on its fundamental component is termed THD or Total Harmonic Distortion. The percentage of total distortion of Harmonics (THD) voltages and currents is formulated as follows (Dugan, McGranaghan et al., 1996) :

$$THD_V = \frac{\sqrt{\sum_2^h V_h^2}}{V_1} \times 100\% \quad (7)$$

Where:

- V_h =Voltage harmonic component
- V₁ =The fundamental frequency voltage (rms)

$$THD_I = \frac{\sqrt{\sum_2^h I_h^2}}{I_1} \times 100\% \quad (8)$$

Where:

- I_h = Current harmonic component
- I₁ = The fundamental frequency current (rms)

2.2 Passive LC Filter

Minimizes the reactive power of an additional criterion required to determine the inductance and capacitance of the passive LC filter. In this study reactive power is used in addition to its criteria based on minimum cost, size, losses, etc. The size of minimization, losses and filter costs, additional criteria based on minimum reactive power also include use (Tella, 2008). However, on harmonics is given in the form of Fourier series expression of the inductance and capacitance of the passive LC filter that is not obtained (Dahono, Purwadi et al., 1995).

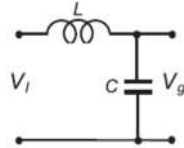

Fig. 2. Passive LC filter circuit (Dewan and Ziogas., 1979).

Designing Passive LC Filter

Passive filter LC consists of parallel relation of passive components inductor and capacitor. In designing passive LC filter first determine the capacitor according to need of power vector and filter inductor.

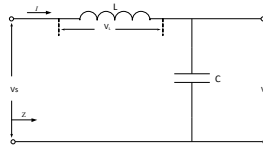

Fig. 3. Passive LC filter impedance circuit.

The steps to be taken in designing the passive LC Filter are as follows (Wakileh G.J., 2001):

a. Calculating the Capacitor Value (C)

- Determine the capacitor size of Q_c based on reactive power requirements for power factor improvement. The reactive power of the capacitor (Q_c) is :

$$Q_c = P\{\tan(\cos^{-1} pf_1) - \tan(\cos^{-1} pf_2)\} \quad (9)$$

Where :

P : Active power (kW).

Pf₁ : Initial power factor

Pf₂ : Final power factor.

- Determine the Reactance of the capacitor (X_C) :

$$X_C = \frac{V^2}{Q_c} \quad (10)$$

Where :

X_C : Capacitive reactance (Ω).

V : Voltage (Volt).

Q_c : Reactive power capacitor (VAR).

- Determine the capacity of the capacitor (C)

$$C = \frac{1}{2\pi f_0 X_C} \quad (11)$$

Where :

C : Capacitance of capacitors (Farad)

f_0 : The fundamental frequency (Hz).

b. Calculate Inductor value (L)

- Determine the impedance Z value of inductor :

$$Z = \frac{V_s}{I} \quad (12)$$

- Determine the inductive reactance of inductor :

$$X_L = \frac{X_C}{h_n^2} \quad (13)$$

- Determine the characteristic reactance of the filter in the tuning order :

$$X_n = h_n X_L \quad (14)$$

- Determine the resistivity (R) of inductor :

$$R = \frac{X_n}{Q} \quad (15)$$

$$Z = \sqrt{R^2 + (\omega L)^2}$$

$$Z^2 = R^2 + (\omega L)^2$$

$$\omega L = \sqrt{Z^2 - R^2}$$

where $\omega = 2\pi f_0$, then the inductance value of the inductor (L) :

$$L = \frac{\sqrt{Z^2 - R^2}}{2\pi f_0} \quad (16)$$

where :

V_s : Voltage source (Volt)

Z : Impedance of inductor (Ω)

I : Current source (A)

L : Inductance (H)

2.3 Passive Single-Tuned Filter

Passive single-tuned filter is a filter consisting of passive components R, L and C connected series, as in Figure 4. Passive single-tuned filter will have a small impedance at resonant frequency so that current has the same frequency with resonance frequency will be deflected through the filter. To overcome harmonics in industrial power systems the most widely used is a passive single-tuned filter.



Fig. 4. Passive single-tuned filter (Chang, Chu et al., 2002)

According to Figure 4, the magnitude of a passive single-tuned filter impedance at the fundamental frequency is:

$$Z_F = R + j(X_L - X_C) \quad (17)$$

Where :

Z_F : Passive single-tuned filter impedance(Ω)

R : Passive single-tuned filter resistance (Ω)

X_L : Passive single-tuned filter inductive reactance(Ω)

X_C : Passive single-tuned filter capacitive reactance (Ω)

Thus a passive single-tuned filter is expected to reduce the harmonic voltage (THDv) and harmonic current (THDi) up to 10-30%. The amount of resistance R of the inductor can be determined by the quality factor of the inductor. Reactance characteristics of filter for n^{th} harmonic.

$$X_n = h_n X_L \quad (18)$$

Where :

X_n : Reactance of passive single-tuned filter characteristics (Ω)

h_n : The order of the n^{th} harmonic

X_L : Inductive reactance of passive single-tuned filter (Ω)

Quality factor:

$$Q = \frac{X_n}{R} \quad (19)$$

Where:

Q : Quality factor from passive single-tuned filter (VAR)

R : Passive single-tuned filter resistance (Ω)

Designing Passive Single-Tuned Filters

Designing a passive single-tuned filter consisting of a series of passive components of the inductor, capacitor and resistance, is how to determine the magnitude of the components of the filter. To determine the need for reactive power can be described in the form of a power triangle such as Figure 5 (Dugan, McGranaghan et al., 1996).

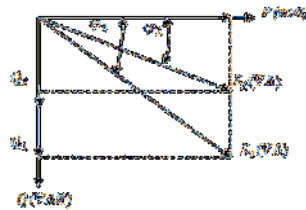

Fig. 5. The power triangle to determine the reactive power requirement Q.

Reactive power requirements can be calculated with the installation of capacitors to improve load power factor. The active power component (P) is generally constant, the apparent power (S) and reactive power (Q) change according to the load power factor.

$$\text{Reactive Power (Q)} = \text{Active Power (P)} \times \tan \phi$$

In reference to the power triangle vector, the reactive power of the initial PF is obtained. The following equation :

$$Q_1 = P \times \tan \varphi_1 \quad (20)$$

The reactive power of the improved PF is obtained in equation :

$$Q_2 = P \times \tan \varphi_2 \quad (21)$$

The capacitor rating required to improve the power factor is:

$$\text{Reactive Power } \Delta Q = Q_1 - Q_2 \quad (22)$$

$$\Delta Q = P(\tan \varphi_1 - \tan \varphi_2) \quad (23)$$

The value of ΔQ obtained, then determines the value of capacitive reactance and the capacitor capacitance value required to improve the power factor is as follows.

- Determine the capacity size of the Q_c capacitor based on reactive power requirements for power factor improvement. The reactive power of the capacitor (Q_c) is :

$$Q_c = \{P \tan(\cos^{-1} pf_1) - \tan(\cos^{-1} pf_2)\} \quad (24)$$

Where :

P : Load (kW)

pf₁ : Initial power factor

pf₂ : Final power factor

- Determine the Reactance of the capacitor (X_c) :

$$X_c = \frac{V^2}{Q_c} \quad (25)$$

Where :

X_c : Capacitive reactance (Ω).

V : Voltage (Volt).

Q_c : Reactive power capacitor (VAR).

- Determine the capacity of the capacitor (C) :

$$C = \frac{1}{2 \pi f_0 X_c} \quad (26)$$

Where:

C : Capacitance of capacitors (Farad)

f_0 : The fundamental frequency (Hz).

- Determine the inductive reactance of the inductor(X_L):

$$X_L = \frac{X_c}{h_n^2} \quad (27)$$

- Determine the inductance of the inductor (L):

$$L = \frac{X_L}{2 \pi f_0} \quad (28)$$

- Determine the characteristic reactance of the filter (X_n) :

$$X_n = h_n X_L \quad (29)$$

- Determine the resistivity (R) of the inductor:

$$R = \frac{X_n}{Q} \quad (30)$$

Where :

R : The resistance of the inductor (Ω)

Q : Quality factor

3. Research Methods

3.1 Technical Measurement

The data was collected by measurement using a Fluke 435 Power Quality Analyzer (PQA) instrument in PCC current transformer at secondary transformer of PT. Gunung Gahapi Sakti.

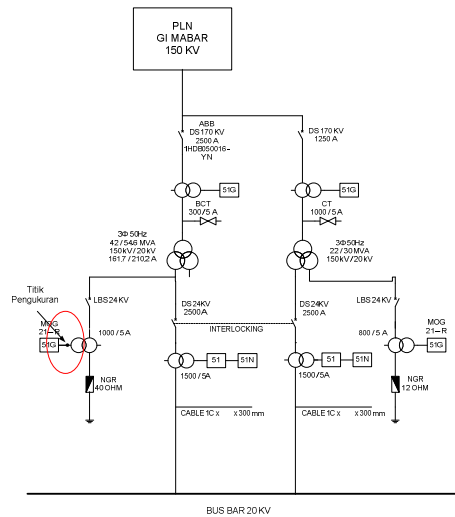

Fig.6. Measurement Point.

4. Data Analysis And Discussion

4.1 Measurement Data

The following data is taken by measuring the secondary power transformer 20 kV using the Fluke 435 power quality meter. The measurement data are shown in the following table 2.

Table 2. Measuring data result.

Parameter	Unit	Current Transformer (CT)
S (Apparent Power)	VA	12.667
P (Active Power)	Watt	12.5
Q (Reactive Power)	VAR	1.833

PF (Power Factor)		0.80
THD _v	%	1.33
THD _i	%	24.8
Frequency	Hz	50
V (Phase Voltage)	Volt	58.69
I (Phase Current)	Ampere	1.001

In the Table 2 shows that the data measurements Current Individual Harmonic Distortion (IHD_i) and Voltage Individual Harmonic Distortion (IHD_v) of each harmonic order. The harmonic order shown is the odd harmonic order of the 1st order up to the 15th order with different values for each harmonic.

Table 3. Data of harmonic current and voltage measurement results.

Harmonic Order (n th)	Individual Harmonic Distortion (IHD)		THD i (%)	THD v (%)
	Current (i) (%)	Voltage (v) (%)		
3	2.85	0.15		
5	23.81	1.18		
7	6.22	0.23		
9	0.38	0.02	24.8	1.23
11	0.73	0.06		
13	0.12	0.02		
15	0.04	0.03		

4.2 Comparison of Harmonic Current Measurement Results On Current Transformers With IEEE Standard 519 - 1992

Before designing the passive LC filter it is better to know in advance the harmonic current order of the current transformer of any measurement that is not in accordance with the standard. In Table 4 we can see harmonic current classification on current transformer from measurement result based on IEEE standard 519 - 1992, where harmonic current from 3rd order up to 15th order compared to IEEE 519-1992 standard.

Table 4. Comparison of harmonic current measurement results on current transformer with IEEE standard 519 – 1992.

Harmonic Order	IHD _i (%)	IEEE 519-1992 Standard IHD _i (%)	Information
3	2,85	12	Suitable
5	23,8	12	Not Suitable
7	6,22	12	Suitable
9	0,38	12	Suitable
11	0,73	5,5	Suitable

Harmonic Order	IHD_i (%)	IEEE 519-1992 Standard IHD_i (%)	Information
13	0,12	5,5	Suitable
15	0,04	5,5	Suitable

4.3 Circuit Simulation Before Filter Installation

The series of simulations consists of current individual harmonic distortion (IHDi) 3rd order up to the order of the 15th. The data on the simulation result must be adjusted with the measurement data that has been done on the current transformer.

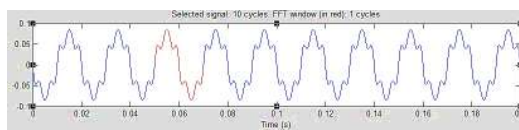

Fig. 7. Current Graphic before filter installation.

The harmonic spectrum of the input current wave from Figure 7 is shown in Figure 8 as follows:

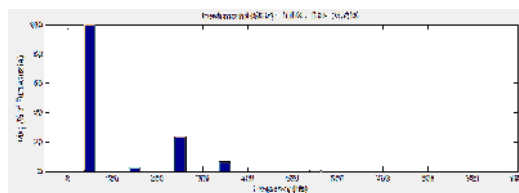

Fig. 8. Harmonic current spectrum before filter installation.

4.4 Simulation Circuit After Passive LC Filter Installation

The simulation circuit consists of one passive LC filter, a resistor and current individual harmonic distortion (IHDi) of the 3rd order up to the 15th order. The passive LC filter consists of a capacitor and inductor connected in series and its value has been calculated previously. The passive LC filters are connected in parallel to the system. Current waveform and current harmonic spectrum are obtained from Block Power GUI of Fast Fourier Transform (FFT) Analysis as shown in Fig. 9.

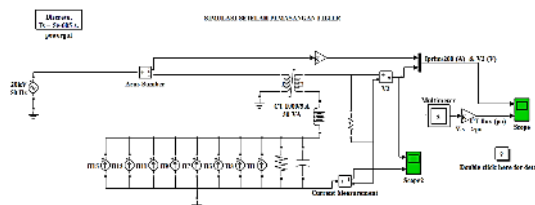

Fig. 9. Simulation circuit after passive LC filter installation.

4.5 Harmonic Results After Use of Passive LC Filter

The simulation results from the Fig. 9 circuit obtained the output graphic as Fig. 10 :

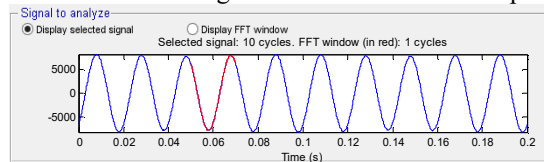

Fig. 10. Current graphic after installation of passive LC filter.

For the harmonic spectrum of the graphic of the current of Figure 10, shown in Figure 11:

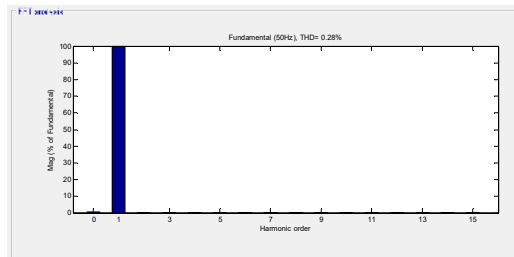

Fig. 11. Current spectrum after installation of passive LC filter.

4.6 Simulation Circuit After Passive Single-Tuned Filter Installation

Passive single-tuned filterS consists of a capacitor, inductor, and resistor connected in series and its value has been taken into account before. Passive single-tuned filters are connected in parallel to the system.

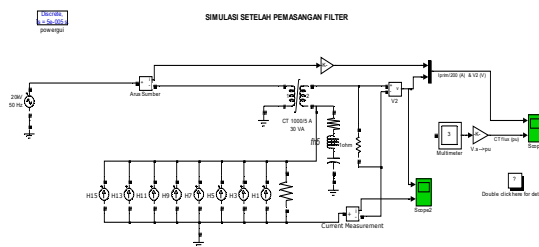

Fig. 12. Simulation Circuit After Filter Installation

4.7 Harmonic Results After Use of Passive Single-Tuned Filter

The simulation results from the circuit of Figure 12 obtained the output graphic as shown in Figure 13:

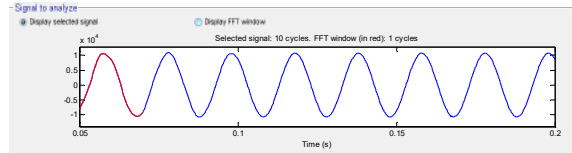

Fig. 13. Current graphic after installation of passive single-tuned filter.
For the harmonic spectrum of the graphic of the current of Figure 13, shown in Figure 14:

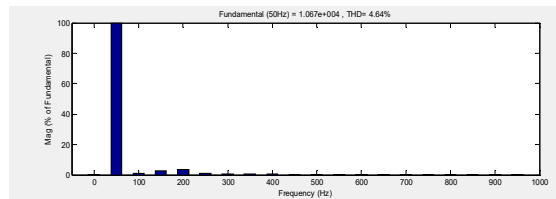

Fig. 14. Current spectrum after installation of Passive Single Tuned filter

From the comparison of the use of passive filter LC and Passive Single-Tuned Filter obtained the current harmonic spectrum as in Table 5.

Table 5. Comparison of use of Passive LC and Passive Single-Tuned Filters

Parameter	Measurement	Result	Passive LC Filter	Passive Single-Tuned Filter
r	(%)	(%)	(%)	(%)
IHD _i orde 1	100	100	100	100
IHD _i orde 3	2,85	0.10	2.54	
IHD _i orde 5	23,81	0.04	1.14	
IHD _i orde 7	6,22	0.02	0.53	
IHD _i orde 9	0,38	0.01	0.36	
IHD _i orde 11	0,73	0.01	0.27	
IHD _i orde 13	0,12	0.01	0.22	
IHD _i orde 15	0,04	0.01	0.19	
THDi	24.8	0.28	2.54	

5. CONCLUSIONS

After doing research by comparing the use of passive LC filter and Passive Single-Tuned Filter on current transformer yield obtained harmonic current content successfully reduced and in accordance with the standard set IEEE 519-1992. The fifth order harmonic current value decreases from 23.81% to 0.04% using passive LC filter and 1.14% using passive single-tuned filter and total harmonic current distortion 24.8% to 0.28% using a passive LC and 2.54% filter using a passive single-tuned filter, so it is clear that LC passive filters are better used to reduce harmonic content compared to single-tuned passive filters in reducing the harmonics emerging in the current transformer.

REFERENCES

- [1] Arrillaga, J. and N. R. Watson (2004). "Power system harmonics". England, Wiley.

- [2] Irianto, C. G., et al. (2008). "Mengurangi Harmonisa Pada Transformator 3 Fasa". JETri 7: 53-68.
- [3] Dugan, R. C., et al. (1996). "Electrical power systems quality". New York, McGraw-Hill
- [4] Tella, P. C. (2008). "The Study Of Singe Phase Diode Rectifiers With High Power Factor And Low Total Harmonic Distortion". Columbia, University of Missouri. Master of Science
- [5] Dahono, P. A., et al. (1995). "An LC filter design method for single-phase PWM inverters". Power Electronics and Drive Systems, 1995., Proceedings of 1995 International Conference on.
- [6] Dewan, S. B. and P. D. Ziogas (1979). "Optimum Filter Design for a Single-Phase Solid-State UPS System". IEEE Transactions on Industry Applications IA-15(6): 664-669.
- [7] Wakileh G.J, (2001), "Power System Harmonics: Fundamental, Analysis and Filter Design". Springer Velag Press.